

D

# GESAMTKATALOG 2024

**DELSCHEN**  
Spezialwerk für Sonnenschirmständer  
Quality Umbrella Bases

*For the sunny days of life  
Für die Sonnentage im Leben*

[WWW.DELSCHEN.COM](http://WWW.DELSCHEN.COM)

For the sunny days of life  
Für die Sonnentage im Leben



Certification: Integrated management system according to ISO 9001, 14001, 28000 and ASM regulations.

Zertifizierung: Integriertes Managementsystem nach den Vorgaben von ISO 9001, 14001, 28000 und ASM.



We care about the environment  
Der Umwelt zuliebe

**Remarks:**

Minimum order: pertaining to pallets and/or units  
Shipping by truck: on exchangeable Euro pallets  
Sale: we only sell wholesale or to retailers, no sales to end consumers, no warehouse sales

**Hinweise:**

Mindestabnahme: Palettenabnahme, bzw. Verpackungseinheit (VE)  
Versand: per LKW auf austauschbaren Euro-Paletten  
Verkauf: ausschließlich an Großabnehmer, kein Direktverkauf an Endverbraucher, kein Lagerverkauf

4

**Fillable Bases**  
Befüllbare  
Schirmständer



8

**Concrete filled Umbrella Bases**  
Betongefüllte  
Schirmständer



18

**Concrete Bases**  
Naturbetonständer



37

**Granite Bases**  
Granitständer



43

**Steel Bases**  
Metallständer



48

**Stainless Steel Bases**  
Edelstahlständer



50

**Ground Tubes**  
Bodenhülsen

51

**Lawn Spikes**  
Bodenspieße

52

**Patio Tile Bases**  
Plattenständer

55

**Umbrella Clamps**  
Schirmklammern

56

**Fold Away Bases**  
Klappständer

56

**Spare Parts**  
Ersatzteile

D

## Fillable Bases

Befüllbare Schirmständer



**To be filled with water or sand  
Available in many different colours!**

Befüllbar mit Sand oder Wasser  
In vielen verschiedenen Farben erhältlich!

## Easy Line

- Base made from durable and recyclable polyethylene
- Built-in handle for convenient portability
- Centralising self-tightening and angle correcting cap
- For transportation purposes the tube is housed underneath the base

## Easy Line

- Hohlkörper aus Polyäthylen
- Stabiler Handgriff für einfachen Transport
- Konischer Rohrstock mit Dreh-Konterverschluss
- Zentrierende, schirmschonende Klemmteile mit Überwurfmutter
- Rohr beim Transport im Boden eingeklemmt



● (106)

## 6100



### 17 L

Base/Fuß: 390 x 390 x 145 mm

**Factory Pack: 48 pcs. per carton, 96 pcs. per pallet**  
**VE: 48 Stück pro Karton, 96 Stück pro Palette**

Colours Farben	Resin Tube Kunststoffrohr	Order-No. Bestell.-Nr.
○ white / weiß	Ø 17-33 mm	6100-131-102
● steel grey / eisengrau	Ø 17-33 mm	6100-132-106

### **i** Information

Other colours available on request./Weitere Farben auf Anfrage.

Weight empty: 0,75 kg, filled with water: 17 kg\*, filled with sand: 26 kg\*  
 Leergewicht: 0,75 kg, Füllgewicht Wasser: 17 kg\*, Füllgewicht Sand: 26 kg\*

## 6000



### 20 L

Base/Fuß: 450 x 450 x 140 mm

**Factory Pack: 30 pcs. per carton, 60 pcs. per pallet**  
**VE: 30 Stück pro Karton, 60 Stück pro Palette**

Colours Farben	Resin Tube Kunststoffrohr	Order-No. Bestell.-Nr.
○ white / weiß	Ø 18-38 mm	6000-102-102
● steel grey / eisengrau	Ø 18-38 mm	6000-111-106

### **i** Information

Other colours available on request./Weitere Farben auf Anfrage.

Weight empty: 0,95 kg, filled with water: 20 kg\*, filled with sand: 30 kg\*  
 Leergewicht: 0,95 kg, Füllgewicht Wasser: 20 kg\*, Füllgewicht Sand: 30 kg\*

\* Approximate weight if fully filled \* Bei voller Befüllung

# Fillable Umbrella Bases

- Base made from durable and recyclable polyethylene
- Built-in handle for convenient portability
- Centralising self-tightening and angle correcting cap
- For transportation purposes the tube is housed underneath the base
- Hohlkörper aus Polyäthylen
- Stabiler Handgriff für einfachen Transport
- Konischer Rohrstock mit Dreh-Konterverschluss
- Zentrierende, schirmschonende Klemmteile mit Überwurfmutter
- Rohr beim Transport im Boden eingeklemmt



**6502**

**24 L**  
Base/Fuß: 480 x 480 x 140 mm

**Factory Pack: 28 pcs. per carton, 56 pcs. per pallet**  
**VE: 28 Stück pro Karton, 56 Stück pro Palette**

Colours Farben	Resin Tube Kunststoffrohr	Order-No. Bestell.-Nr.
○ white / weiß	Ø 18-38 mm	6502-102-102

**i Information**

Weight empty: 1 kg, filled with water: 24 kg\*, filled with sand: 38 kg\*  
Leergewicht: 1 kg, Füllgewicht Wasser: 24 kg\*, Füllgewicht Sand: 38 kg\*



**6603**

**24 L**  
Base/Fuß: 480 x 480 x 140 mm

**Factory Pack: 28 pcs. per carton, 56 pcs. per pallet**  
**VE: 28 Stück pro Karton, 56 Stück pro Palette**

Colours Farben	Resin Tube Kunststoffrohr	Order-No. Bestell.-Nr.
○ white / weiß	Ø 18-38 mm	6603-102-102
● steel grey / eisengrau	Ø 18-38 mm	6603-111-106

**i Information**

Weight empty: 1 kg, filled with water: 24 kg\*, filled with sand: 38 kg\*  
Leergewicht: 1 kg, Füllgewicht Wasser: 24 kg\*, Füllgewicht Sand: 38 kg\*



- Mobility provided by 2 solid rollers supported by durable aluminium shaft enclosed within moulding.
- Mobil durch 2 stabile Rollen und wetterfeste Aluminiumachse.



\* Approximate weight if fully filled \* Bei voller Befüllung



**6800**



**30 L**

Base/Fuß: Ø 500 x 180 mm

**Factory Pack: 17 pcs. per carton, 34 pcs. per pallet**  
**VE: 17 Stück pro Karton, 34 Stück pro Palette**

Colour Farbe	Resin Tube Kunststoffrohr	Order-No. Bestell.-Nr.
● steel grey / eisengrau	Ø 26-55 mm	6800-123-106

**i Information**

Weight empty: 1,9 kg, filled with water: 30 kg\*, filled with sand: 50 kg\*  
 Leergewicht: 1,9 kg, Füllgewicht Wasser: 30 kg\*, Füllgewicht Sand: 50 kg\*

- Extra support for umbrella provided by T-shaped locking device underneath base

- T-Konterstück im Boden garantiert höchste Stabilität

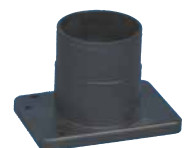

**C042-000-108**

\* Approximate weight if fully filled \* Bei voller Befüllung

D

# Concrete filled Umbrella Bases

## Betongefüllte Schirmständer



**Many sizes and colours available!**  
Erhältlich in vielen Größen und Farben!



○ (102)



**04101**



**18 kg**

Base/Fuß: ø 400 mm

**Factory Pack: 48 pcs. per pallet / VE: 48 Stück pro Palette**

Colours Farben	Resin Tube Kunststoffrohr	Order-No. Bestell.-Nr.
○ white / weiß	Ø 18-38 mm	4101-204-102
● steel grey / eisengrau	Ø 18-38 mm	4101-223-106

**M04101**



**18 kg**

Base/Fuß: ø 400 mm

**Factory Pack: 48 pcs. per pallet / VE: 48 Stück pro Palette**

Colours Farben	Aluminum Tube Aluminium Rohr	Order-No. Bestell.-Nr.
○ white / weiß	Ø 26-44 mm	4101-301-102
● steel grey / eisengrau	Ø 26-44 mm	4101-303-106

# Concrete filled Umbrella Bases



- Balcony Umbrella Base
- Rectangular space-saving design
- Available with resin or aluminum tube
- Packed in cardboard box
- Balkonschirmständer
- Rechteckiges, raumsparendes Design
- Wahlweise mit Kunststoff- oder Aluminiumrohr
- Einzeln im Karton verpackt



- For wind exposed balconies we recommend the use of umbrella clamps, see page 55.
- Auf windigen Balkonen empfehlen wir eine zusätzliche Schirmklammer, weitere Details auf Seite 55.

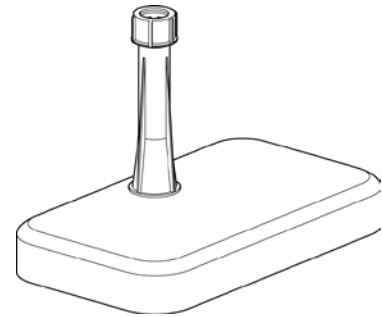

**07001**



**20 kg**

Base/Fuß: 500 x 285 mm

**Factory Pack: 50 pcs. per pallet / VE: 50 Stück pro Palette**

Colours Farben	Resin Tube Kunststoffrohr	Order-No. Bestell.-Nr.
<input type="radio"/> white / weiß	Ø 18-38 mm	7001-204-102
<input checked="" type="radio"/> steel grey / eisengrau	Ø 18-38 mm	7001-223-106

**M7001**



**20 kg**

Base/Fuß: 500 x 285 mm

**Factory Pack: 50 pcs. per pallet / VE: 50 Stück pro Palette**

Colours Farben	Aluminum Tube Aluminium Rohr	Order-No. Bestell.-Nr.
<input type="radio"/> white / weiß	Ø 26-44 mm	7001-301-102
<input checked="" type="radio"/> steel grey / eisengrau	Ø 26-44 mm	7001-303-106

## Protective Mat

- Suitable for 20 and 25 kg bases
- To prevent scratches on floor surface, Order-No.  
C150-000-108 (20 kg)  
C040-000-108 (25 kg)

## Bodenschutzplatte

- Passend zu 20 und 25 kg Modellen
- Schützt die Terrassenfliesen, Bestell-Nr.  
C150-000-108 (20 kg)  
C040-000-108 (25 kg)



**03701**  
**M3701**



**15 kg**  
Base/Fuß: ø 360 mm

**Factory Pack: 60 pcs. per pallet / VE: 60 Stück pro Palette**

Colours Farben	Resin Tube Kunststoffrohr	Aluminum Tube Aluminium Rohr	Order-No. Bestell.-Nr.
○ white / weiß	Ø 18-38 mm		3701-204-102
● steel grey / eisengrau	Ø 18-38 mm		3701-223-106
● silver / silber	Ø 18-38 mm		3701-229-124

**04001**  
**M4001**



**20 kg**  
Base/Fuß: ø 400 mm

**Factory Pack: 48 pcs. per pallet / VE: 48 Stück pro Palette**

Colours Farben	Resin Tube Kunststoffrohr	Aluminum Tube Aluminium Rohr	Order-No. Bestell.-Nr.
○ white / weiß	Ø 18-38 mm		4001-204-102
● steel grey / eisengrau	Ø 18-38 mm		4001-223-106
○ white / weiß		Ø 26-44 mm	4001-301-102
● steel grey / eisengrau		Ø 26-44 mm	4001-303-106



# Concrete filled Umbrella Bases



**04251  
M4251**



**04252  
M4252**



**25 kg**  
Base/Fuß: ø 425 mm

**Factory Pack: 42 pcs. per pallet / VE: 42 Stück pro Palette**

Colours Farben	Resin Tube Kunststoffrohr	Aluminum Tube Aluminium Rohr	Order-No. Bestell.-Nr.
<input type="radio"/> white / weiß	Ø 18-38 mm		4251-204-102
<input checked="" type="radio"/> steel grey / eisengrau	Ø 18-38 mm		4251-223-106
<input type="radio"/> white / weiß		Ø 26-44 mm	4251-301-102
<input checked="" type="radio"/> steel grey / eisengrau		Ø 26-44 mm	4251-303-106
<input type="radio"/> white / weiß	Ø 26-55 mm		4252-202-102
<input checked="" type="radio"/> steel grey / eisengrau	Ø 26-55 mm		4252-219-106
<input type="radio"/> white / weiß		Ø 26-55 mm	4252-402-102

- Resin cover, filled with concrete, aluminum tube or resin tube
- Betongefüllte Kunststoffhaube mit wetterfestem Aluminiumrohr oder Kunststoffrohr

### Centralising Cups

- Our conical cups provide extra stability for the umbrella pole.
- Suitable for aluminum tubes  
C116-000-100 (Ø 26-44 mm)  
C117-000-100 (Ø 26-55 mm)

### Zentriereinsätze

- Unsere Einsätze zentrieren den Schirmstock im Standrohr.
- Passend für Aluminiumrohre  
C116-000-100 (Ø 26-44 mm)  
C117-000-100 (Ø 26-55 mm)

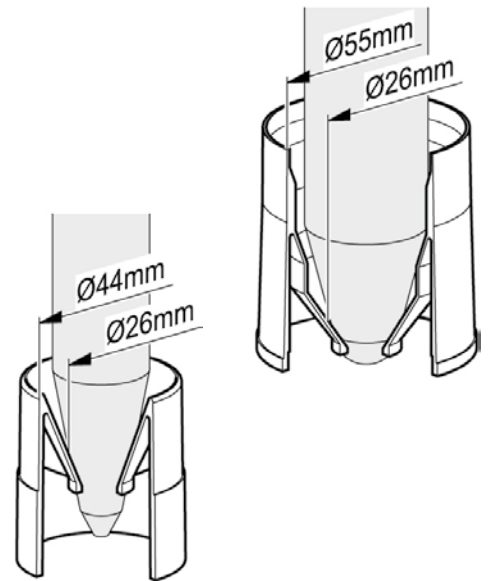

**05001  
M5001**

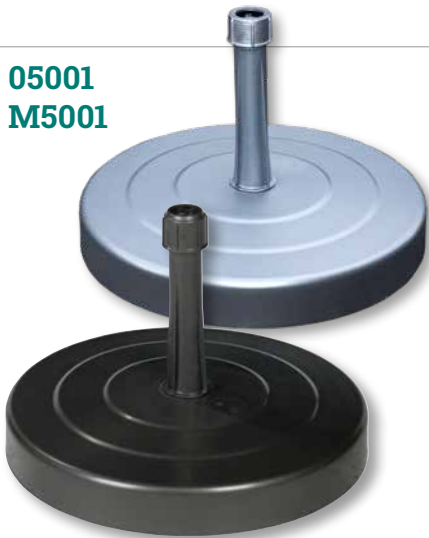

**05002  
M50053**



**30 kg**  
Base/Fuß: ø 500 mm

**Factory Pack: 28 pcs. per pallet / VE: 28 Stück pro Palette**

Colours Farben	Resin Tube Kunststoffrohr	Aluminum Tube Aluminium Rohr	Order-No. Bestell.-Nr.
○ white / weiß	Ø 18-38 mm		5001-204-102
● steel grey / eisengrau	Ø 18-38 mm		5001-223-106
● silver / silber	Ø 18-38 mm		5001-229-124
○ white / weiß		Ø 26-44 mm	5001-301-102
● steel grey / eisengrau		Ø 26-44 mm	5001-303-106
○ white / weiß	Ø 26-55 mm		5002-202-102
● steel grey / eisengrau	Ø 26-55 mm		5002-219-106
○ white / weiß		Ø 26-55 mm	5002-401-102
● steel grey / eisengrau		Ø 26-55 mm	5002-412-106
● silver / silber		Ø 26-55 mm	5002-450-124



# Concrete filled Umbrella Bases

- Resin cover, filled with concrete
- Heavy, but easy to move
- 3 rollers supported by strong aluminum shaft
- Built-in handle for convenient portability
- Gliders to prevent scratches on floor surfaces
- Betongefüllte Kunststoffhaube
- Schwer, aber leicht zu bewegen
- 3 verdeckte Rollen, gelagert auf wetterfester Aluminiumachse
- Stabiler und praktischer Handgriff
- Inkl. Bodenschutzstopfen zum Schutz der Terrassenfliesen



● (106)



**46038**

**28 kg**

Base/Fuß: 425 x 465 mm

**Factory Pack: 36 pcs. per pallet / VE: 36 Stück pro Palette**

Colours Farben	Resin Tube Kunststoffrohr	Order-No. Bestell.-Nr.
○ white / weiß	Ø 18-38 mm	4601-204-102
● steel grey / eisengrau	Ø 18-38 mm	4601-223-106



**46042**

**28 kg**

Base/Fuß: 425 x 465 mm

**Factory Pack: 36 pcs. per pallet / VE: 36 Stück pro Palette**

Colours Farben	Aluminum Tube Aluminium Rohr	Order-No. Bestell.-Nr.
○ white / weiß	Ø 26-44 mm	4601-301-102
● steel grey / eisengrau	Ø 26-44 mm	4601-303-106

**46055**



**28 kg**

Base/Fuß: 425 x 465 mm

**Factory Pack: 36 pcs. per pallet / VE: 36 Stück pro Palette**

Colours Farben	Resin Tube Kunststoffrohr	Order-No. Bestell.-Nr.
○ white / weiß	Ø 26-55 mm	4602-202-102
● steel grey / eisengrau	Ø 26-55 mm	4602-219-106

**46057**



**28 kg**

Base/Fuß: 425 x 465 mm

**Factory Pack: 36 pcs. per pallet / VE: 36 Stück pro Palette**

Colours Farben	Aluminum Tube Aluminium Rohr	Order-No. Bestell.-Nr.
○ white / weiß	Ø 26-55 mm	4602-402-102
● steel grey / eisengrau	Ø 26-55 mm	4602-412-106

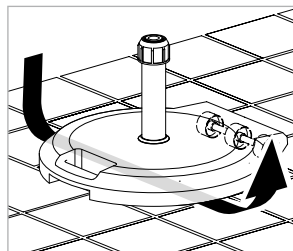
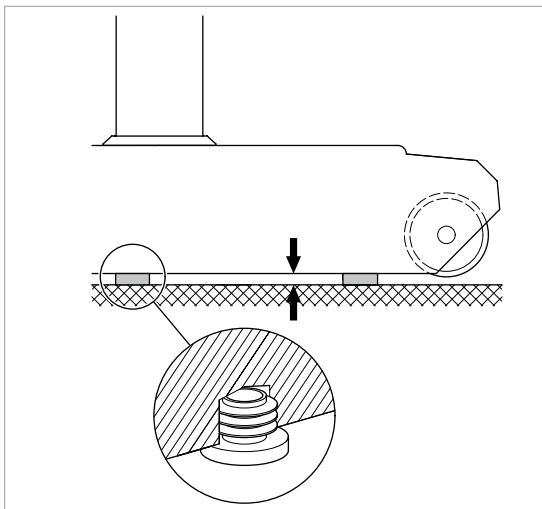

- Our gliders offer a secure method to prevent scratches on floor surfaces. In addition, air is allowed to circulate underneath the base, preventing build up of fungus.
- Unsere Bodenschutzstopfen für diese Serien bieten einen sicheren Schutz gegen Verkratzen Ihrer Terrassenfliesen. Zusätzlich sorgen sie für eine Durchlüftung. Dadurch wird die Bildung eines Mikroklimas unter dem Standfuß verhindert.



- Bag with 4 gliders: Art.-No. X001-004-108
- Bag with 6 gliders: Art.-No. X001-006-108
- Bag with 8 gliders: Art.-No. X001-008-108
- Single glider: Art.-No. C113-000-108

- Beutel mit 4 Stopfen: Art.-No. X001-004-108
- Beutel mit 6 Stopfen: Art.-No. X001-006-108
- Beutel mit 8 Stopfen: Art.-No. X001-008-108
- Bodenschutzstopfen einzeln: Art.-No. C113-000-108



# Concrete filled Umbrella Bases



**61055**



**38 kg**

Base/Fuß: ø 600 mm

**Factory Pack: 20 pcs. per pallet / VE: 20 Stück pro Palette**

Colours Farben	Resin Tube Kunststoffrohr	Aluminum Tube Aluminium Rohr	Order-No. Bestell.-Nr.
○ white / weiß	Ø 26-55 mm		0610-202-102
● steel grey / eisengrau	Ø 26-55 mm		0610-219-106
○ white / weiß		Ø 26-55 mm	0610-401-102
● steel grey / eisengrau		Ø 26-55 mm	0610-412-106



- Resin cover, filled with concrete
- Flat and modern design
- Centralising cup within tube
- Customised logo available on request.
- Betongefüllte Kunststoffhaube
- Flaches, modernes Design
- Zentriereinsatz im Rohrende
- Auf Wunsch mit Firmenlogo (Mindestmengen).



**60053**



**40 kg**

Base/Fuß: ø 600 mm

**Factory Pack: 20 pcs. per pallet / VE: 20 Stück pro Palette**

Colours Farben	Resin Tube Kunststoffrohr	Aluminum Tube Aluminium Rohr	Order-No. Bestell.-Nr.
○ white / weiß	Ø 26-55 mm		0600-202-102
● steel grey / eisengrau	Ø 26-55 mm		0600-219-106
○ white / weiß		Ø 26-55 mm	0600-401-102
● steel grey / eisengrau		Ø 26-55 mm	0600-412-106
● silver / silber		Ø 26-55 mm	0600-450-124

**70055**



**60 kg**

Base/Fuß: ø 700 mm

**Factory Pack: 16 pcs. per pallet / VE: 16 Stück pro Palette**

Colours Farben	Handles Griffe	Aluminum Tube Aluminium Rohr	Order-No. Bestell.-Nr.
○ white / weiß	galvanized steel handles verzinkte Stahlgriffe	Ø 26-55 mm	0702-401-102

D

# Concrete Bases

## Naturbetonständer



**25 kg - 160 kg**  
**Suitable for private or commercial use.**  
Für den Garten- und Objektbereich

### Concrete Base

- Water drainage through outlet in tube
- Gliders underneath base to prevent scratches on floor surfaces
- Suitable for castors

### Naturbetonständer

- Wasserabfluss durch Standrohr
- Bodenschutzstopfen zum Schutz der Terrassenfliesen
- Geeignet für Rollen



**4943**

**25 kg**  
Base/Fuß: ø 460 mm

**Factory Pack: 28 pcs. per pallet / VE: 28 Stück pro Palette**

Colours Farben	Resin Tube KU-Rohr	Order-No. Bestell.-Nr.
● charcoal / anthrazit	Ø 18-38 mm	4943-223-203
○ white / weiß	Ø 18-38 mm	4943-204-216
● black / schwarz	Ø 18-38 mm	4943-224-214



**4944**

**27 kg**  
Base/Fuß: ø 460 mm

**Factory Pack: 28 pcs. per pallet / VE: 28 Stück pro Palette**

Colours Farben	Stainless Steel Tube Edelstahlrohr	Order-No. Bestell.-Nr.
● grey / grau	Ø 25-44 mm	4944-372-200
	Ø 25-55 mm	4944-373-200
● charcoal / anthrazit	Ø 25-44 mm	4944-372-203
	Ø 25-55 mm	4944-373-203
○ white / weiß	Ø 25-55 mm	4944-342-216
● taupe / taupe	Ø 25-55 mm	4944-344-217
● black / schwarz	Ø 25-55 mm	4944-343-214

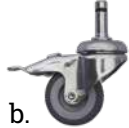
Accessories / Zubehör	Castors type / Rollenart	Order-No. / Bestell.-Nr.
 a.  b.	a. 6 castors / Kunststoffrollen ø 50mm	X037-296-100
	b. 6 metal castors / Metallrollen ø 50mm	X038-296-310



# Concrete Bases

Wide variety of colours, also special colours are possible. Select from a comprehensive range and be inspired by the variety of shapes and colours available.

Große Farbvielfalt, auch Sonderfarben sind möglich. Wählen Sie aus einem umfangreichen Sortiment und lassen Sie sich von der Form- und Farbvielfalt inspirieren.



**4912**

- With carrying handles
- Mit Seilgriff

**4911**



**4912**



**30 kg**

Base/Fuß: ø 490 mm

**Factory Pack: 28 pcs. per pallet / VE: 28 Stück pro Palette**

Colours Farben	Stainless Steel Tube Edelstahlrohr	Order-No. Bestell.-Nr.	Order-No. Bestell.-Nr.
● grey / grau	Ø 25-44 mm	4911-372-200	4912-372-200
	Ø 25-55 mm	4911-373-200	4912-373-200
● charcoal / anthrazit	Ø 25-44 mm	4911-372-203	4912-372-203
	Ø 25-55 mm	4911-373-203	4912-373-203
○ white / weiß	Ø 25-55 mm	4911-342-216	4912-342-216
● taupe / taupe	Ø 25-55 mm	4911-344-217	4912-344-217
● black / schwarz	Ø 25-55 mm	4911-343-214	4912-343-214

## Accessories / Zubehör



## Castors type / Rollenart

## Order-No. / Bestell.-Nr.

a. 6 castors / Kunststoffrollen ø 50mm

X037-296-100

b. 6 metal castors / Metallrollen ø 50mm

X038-296-310

**4960**



**40 kg**

Base/Fuß: ø 590 mm

**Factory Pack: 18 pcs. per pallet / VE: 18 Stück pro Palette**

Colours Farben	Stainless Steel Tube Edelstahlrohr	Order-No. Bestell.-Nr.
● grey / grau	Ø 25-55 mm	4960-373-200
● charcoal / anthrazit	Ø 25-55 mm	4960-373-203
○ white / weiß	Ø 25-55 mm	4960-342-216
● taupe / taupe	Ø 25-55 mm	4960-344-217
● brown / braun	Ø 25-55 mm	4960-345-218
● black / schwarz	Ø 25-55 mm	4960-343-214

**4970**



**60 kg**

Base/Fuß: ø 590 mm

**Factory Pack: 16 pcs. per pallet / VE: 16 Stück pro Palette**

Colours Farben	Stainless Steel Tube Edelstahlrohr	Order-No. Bestell.-Nr.
● grey / grau	Ø 25-55 mm	4970-373-200
● charcoal / anthrazit	Ø 25-55 mm	4970-373-203
● black / schwarz	Ø 25-55 mm	4970-343-214
● grey / grau	Ø 35-70 mm	4970-374-200
● charcoal / anthrazit	Ø 35-70 mm	4970-374-203
● grey / grau	Ø 61 mm	4970-377-200
● charcoal / anthrazit	Ø 61 mm	4970-377-203

**Accessories / Zubehör**

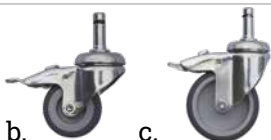

b. c.

Castors type / Rollenart	Order-No. / Bestell.-Nr.
b. 6 metal castors / Metallrollen ø 50mm	X038-296-310
c. 6 metal castors / Metallrollen ø 75mm	X043-296-310



**4745**



**35 kg**

Base/Fuß: 450 x 450 mm

**Factory Pack: 28 pcs. per pallet / VE: 28 Stück pro Palette**

Colours Farben	Stainless Steel Tube Edelstahlrohr	Order-No. Bestell.-Nr.
● grey / grau	Ø 25-44 mm	4745-372-200
	Ø 25-55 mm	4745-373-200
● charcoal / anthrazit	Ø 25-44 mm	4745-372-203
	Ø 25-55 mm	4745-373-203
○ white / weiß	Ø 25-55 mm	4745-342-216
● taupe / taupe	Ø 25-55 mm	4745-344-217
● brown / braun	Ø 25-55 mm	4745-345-218
● black / schwarz	Ø 25-55 mm	4745-343-214

**Accessories / Zubehör**



**Castors type / Rollenart**

**Order-No. / Bestell.-Nr.**

a. 4 castors / Kunststoffrollen ø 50mm

X037-294-100

b. 4 metal castors / Metallrollen ø 50mm

X038-294-310



### Mobile Concrete Base

- With wheels and carrying handle
- Stainless steel tube with water drainage
- Centralising cup within tube and adapter system to support umbrella pole
- Gliders underneath base to prevent scratches on floor surfaces

### Mobiler Naturbetonständer

- Mit breiten Rollen und Seilgriff.
- Stabiles, wetterfestes Edelstahlrohr mit Wasserabfluss.
- 5 Adaptoreinsätze und Zentrier-einsatz im Rohrende sorgen für stabilen Stand für Schirmstöcke  $\varnothing$  25-55 mm.
- Bodenschutzstopfen zum Schutz der Terrassenfliesen.



### Quick release / Schnellspanner

Tube/Rohr 319



**4752**



**45 kg**

Base/Fuß: 520 x 520 mm

**Factory Pack: 18 pcs. per pallet / VE: 18 Stück pro Palette**

Colours Farben	Stainless Steel Tube Edelstahlrohr	Order-No. Bestell.-Nr.
● charcoal / anthrazit	$\varnothing$ 25-55 mm	4752-373-203
<b>Quick release / Schnellspanner</b>		
● charcoal / anthrazit	$\varnothing$ 35-39 mm	4752-319-203



### Octagonal Concrete Base

- 4 recessed grips
- Stainless steel tube
- Water drainage through outlet in tube
- Centralising cup within tube
- Gliders underneath base to prevent scratches on floor surfaces

### Achteckiger Naturbetonständer

- 4 Griffmulden
- Wetterfestes Edelstahlrohr
- Wasserabfluss durch Standrohr
- Zentriereinsatz im Rohrende
- Bodenschutzstopfen zum Schutz der Terrassenfliesen

**4801**  
**50 kg**



**4813**  
**65 kg**  
Base/Fuß: 590 x 590 mm

### Factory Pack: 18 pcs. per pallet / VE: 18 Stück pro Palette

Colours Farben	Stainless Steel Tube Edelstahlrohr	Order-No. Bestell.-Nr.
● grey / grau	Ø 25-55 mm	4801-373-200
● charcoal / anthrazit	Ø 25-55 mm	4801-373-203

### Factory Pack: 16 pcs. per pallet / VE: 16 Stück pro Palette

● grey / grau	Ø 25-55 mm	4813-373-200
● charcoal / anthrazit	Ø 25-55 mm	4813-373-203
● charcoal / anthrazit	Ø 61 mm	4813-377-203



### Accessories 4801 (50kg) / Zubehör 4801 (50 kg) Order-No. / Bestell.-Nr.

Trolley system with telescopic handle Transportsystem mit Teleskopgriff	X034-099-310
--	--------------



NEW / NEU



4715



25 kg  
Base/Fuß: 500 x 390 mm

Factory Pack: 32 pcs. per pallet / VE: 32 Stück pro Palette

Colours Farben	Stainless Steel Tube Edelstahlrohr	Order-No. Bestell.-Nr.
● charcoal / anthrazit	Ø 25-44 mm	4715-372-203
● charcoal / anthrazit	Ø 25-55 mm	4715-373-203



## Square Concrete Base

- 4 recessed grips
- Stainless steel tube
- Water drainage through outlet in tube
- Centralising cup within tube
- Gliders underneath base to prevent scratches on floor surfaces

## Rechteckiger Naturbetonständer

- 4 Griffmulden
- Wetterfestes Edelstahlrohr
- Wasserabfluss durch Standrohr
- Zentriereinsatz im Rohrende
- Bodenschutzstopfen zum Schutz der Terrassenfliesen

**4760**



**60 kg**

Base/Fuß: 590 x 590 mm

**Factory Pack: 16 pcs. per pallet / VE: 16 Stück pro Palette**

Colours Farben	Tube Rohr	Stainless Steel Tube Edelstahlrohr	Order-No. Bestell.-Nr.
● grey / grau	373	Ø 25-55 mm	4760-373-200
● charcoal / anthrazit	373	Ø 25-55 mm	4760-373-203
● grey / grau	374	Ø 35-70 mm	4760-374-200
● charcoal / anthrazit	374	Ø 35-70 mm	4760-374-203
● grey / grau	376	Ø 26-55 mm	4760-376-200
● charcoal / anthrazit	376	Ø 26-55 mm	4760-376-203
● grey / grau	377	Ø 61 mm	4760-377-200
● charcoal / anthrazit	377	Ø 61 mm	4760-377-203

**4790**



**85 kg**

Base/Fuß: 590 x 590 mm

**Factory Pack: 10 pcs. per pallet / VE: 10 Stück pro Palette**

● grey / grau	373	Ø 25-55 mm	4790-373-200
● charcoal / anthrazit	373	Ø 25-55 mm	4790-373-203
● grey / grau	376	Ø 26-55 mm	4790-376-200
● charcoal / anthrazit	376	Ø 26-55 mm	4790-376-203
● grey / grau	377	Ø 61 mm	4790-377-200
● charcoal / anthrazit	377	Ø 61 mm	4790-377-203
● grey / grau	374	Ø 35-70 mm	4790-374-200
● charcoal / anthrazit	374	Ø 35-70 mm	4790-374-203



**4763**



With carrying ropes  
Mit Seilgriffen

**60 kg**

Base/Fuß: 590 x 590 mm

**Factory Pack: 16 pcs. per pallet / VE: 16 Stück pro Palette**

● grey/grau	373	Ø 25-55 mm	4763-373-200
● charcoal/anthrazit	373	Ø 25-55 mm	4763-373-203
● grey/grau	374	Ø 35-70 mm	4763-374-200
● charcoal/anthrazit	374	Ø 35-70 mm	4763-374-203
● grey/grau	376	Ø 26-55 mm	4763-376-200
● charcoal/anthrazit	376	Ø 26-55 mm	4763-376-203
● grey/grau	377	Ø 61 mm	4763-377-200
● charcoal/anthrazit	377	Ø 61 mm	4763-377-203
● grey/grau	319	Ø 35-39 mm	4763-319-200
<b>NEW / NEU</b>		<b>Quick release/Schnellspanner</b>	
● charcoal/anthrazit	319	Ø 35-39 mm	4763-319-203

**Accessories / Zubehör**

4760 / 4763  
4790

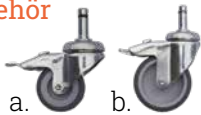

a.

b.

**castors type / Rollenart**

**Order-No. / Bestell.-Nr.**

a. 4 metal castors/ Metallrollen Ø 50 mm

X038-294-310

b. 4 metal castors/ Metallrollen Ø 75 mm

X043-294-310

Ø 25-55 mm

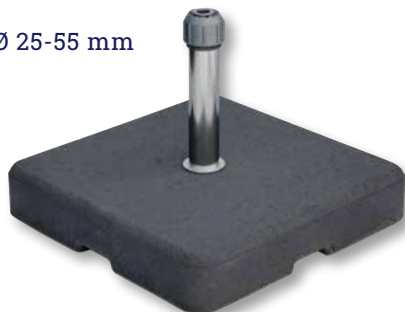

Tube/Rohr 376  
Tightening cap with adapters  
Überwurfmutter mit Adaptern

Ø 61 mm

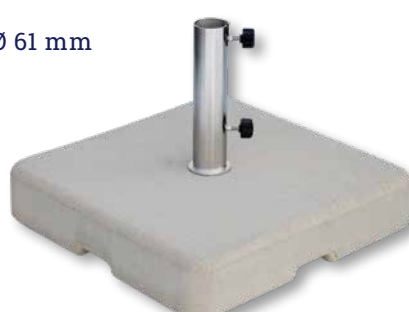

Tube/Rohr 377  
2 stainless steel screws  
2 Edelstahlschrauben

Ø 35-39 mm



Tube/Rohr 319  
Quick release  
Schnellspanner



- Solid concrete bases weighing between 55 and 160 kg suitable for private or commercial use
- Robuste Naturbetonständer von 55-160 kg für den Garten- und Objektbereich

## 5655



**55 kg**

Base/Fuß: Ø 590 mm

**Factory Pack: 10 pcs. per pallet / VE: 10 Stück pro Palette**

Colours Farben	Aluminum Tube Aluminiumrohr	Order-No. Bestell.-Nr.
● grey / grau	Ø 26-55 mm	0562-407-200
● charcoal / anthrazit	Ø 26-55 mm	0562-490-203
○ white / weiß	Ø 26-55 mm	0562-410-216

**i Information**

2 recessed grips  
2 Griffmulden

## 5855



**60 kg**

Base/Fuß: Ø 590 mm

**Factory Pack: 10 pcs. per pallet / VE: 10 Stück pro Palette**

Colours Farben	Aluminum Tube Aluminiumrohr	Order-No. Bestell.-Nr.
● grey / grau	Ø 26-55 mm	0572-407-200
● charcoal / anthrazit	Ø 26-55 mm	0572-490-203
○ white / weiß	Ø 26-55 mm	0572-410-206

**i Information**

2 galvanized handles  
2 verzinkte Handgriffe



**6355**

**70 kg**  
Base/Fuß: Ø 600 mm

Factory Pack: 10 pcs. per pallet / VE: 10 Stück pro Palette		
Colours Farben	Aluminum Tube Aluminiumrohr	Order-No. Bestell.-Nr.
○ grey / grau	Ø 26-55 mm	0632-407-200
● charcoal / anthrazit	Ø 26-55 mm	0632-490-203

**i Information**

2 galvanized handles  
2 verzinkte Handgriffe



**10055**

**110 kg**  
Base/Fuß: Ø 700 mm

Factory Pack: 7 pcs. per pallet / VE: 7 Stück pro Palette		
Colours Farben	Aluminum Tube Aluminiumrohr	Order-No. Bestell.-Nr.
○ grey / grau	Ø 26-55 mm	1002-408-200
● charcoal / anthrazit	Ø 26-55 mm	1002-408-203

**i Information**

2 galvanized handles  
2 verzinkte Handgriffe



**14555**

**160 kg**  
Base/Fuß: Ø 800 mm

Factory Pack: 1 pc. per pallet / VE: 1 Stück pro Palette		
Colours Farben	Aluminum Tube Aluminiumrohr	Order-No. Bestell.-Nr.
○ grey / grau	Ø 25-55 mm	1602-408-200
● charcoal / anthrazit	Ø 25-55 mm	1602-408-203

**i Information**

2 galvanized handles  
2 verzinkte Handgriffe



# Concrete Bases



### Concrete Bases with Stainless Steel Tube

- Detachable stainless steel tube
- Centralising cup within tube
- Water drainage through outlet in tube
- 2 galvanized steel handles

### Naturbetonständer mit Edelstahlrohr

- Wetterfestes Edelstahlrohr
- Zentriereinsatz im Rohrende
- Wasserabfluß durch Standrohr
- 2 verzinkte Handgriffe

**0637**

**75 kg**

Base/Fuß: Ø 600 mm

**1007**

**110 kg**

Base/Fuß: Ø 700 mm

**Factory Pack: 10 pcs. per pallet / VE: 10 Stück pro Palette**

Colours Farben	Stainless Steel Tube Edelstahlrohr	Order-No. Bestell.-Nr.
<input type="radio"/> grey / grau	Ø 25-55 mm	0637-373-200
<input checked="" type="radio"/> charcoal / anthrazit	Ø 25-55 mm	0637-373-203
<input type="radio"/> grey / grau	Ø 61 mm	0637-377-200
<input type="radio"/> grey / grau	Ø 35-70 mm	0637-374-200

**Factory Pack: 7 pcs. per pallet / VE: 7 Stück pro Palette**

<input type="radio"/> grey / grau	Ø 25-55 mm	1007-373-200
<input checked="" type="radio"/> charcoal / anthrazit	Ø 25-55 mm	1007-373-203
<input type="radio"/> grey / grau	Ø 61 mm	1007-377-200
<input type="radio"/> grey / grau	Ø 35-70 mm	1007-374-200



375



376



377

- Further tubes available on request

## Umbrella Bases with Anti-Rotation Bolt

- Our Side-Arm-Umbrella (Cantilever) conceptualised bases feature a built-in safety rod (bayonet type) at the bottom of the tube to prevent the umbrella from turning in windy conditions.
- A grooved umbrella pole is required to take advantage of this feature.

## Spezierschirmständer

- Die für Ampelschirme konzipierten Spezierschirmständer haben einen Arretierstift im Rohrende, welcher verhindert, dass sich der Sonnenschirm bei Windeinfall im Standrohr drehen kann.
- Dieses Konzept setzt den Gebrauch von Sonnenschirmen mit geschlitzten Rohrstöcken voraus.

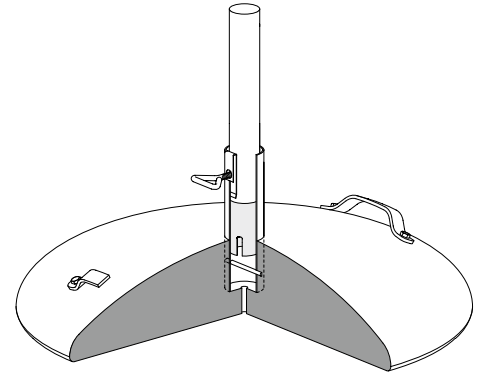

**0905-049-200**

**7049**



**7050**



**7051**



Factory Pack VE Stück	approx. weight Gewicht ca.	Base mm Fuß mm	Aluminum Tube Aluminiumrohr	Order-No. Bestell.-Nr.
6	70kg	Ø 700 mm	Ø 38-53 mm	0705-049-200
6	90kg	Ø 700 mm	Ø 38-53 mm	0905-049-200
6	110kg	Ø 700 mm	Ø 38-53 mm	1005-049-200
1	160kg	Ø 800 mm	Ø 38-53 mm	1605-049-200
● grey / grau				
6	70kg	Ø 700 mm	Ø 25-55 mm	0705-050-200
6	90kg	Ø 700 mm	Ø 25-55 mm	0905-050-200
6	110kg	Ø 700 mm	Ø 25-55 mm	1005-050-200
1	160kg	Ø 800 mm	Ø 25-55 mm	1605-050-200
● grey / grau				
6	70kg	Ø 700 mm	Ø 54-56 mm	0705-051-200
6	90kg	Ø 700 mm	Ø 54-56 mm	0905-051-200
6	110kg	Ø 700 mm	Ø 54-56 mm	1005-051-200
1	160kg	Ø 800 mm	Ø 54-56 mm	1605-051-200
● grey / grau				

**9009**



Factory Pack VE Stück	approx. weight Gewicht ca.	Base mm Fuß mm	Hot-dip Steel Tube feuerverzinktes Stahlrohr	Order-No. Bestell.-Nr.
6	90kg	Ø 700 mm	Ø 54-56 mm	0909-437-200
6	110kg	Ø 700 mm	Ø 54-56 mm	1009-437-200
1	160kg	Ø 800 mm	Ø 54-56 mm	1609-437-200

grey / grau

**Heavy concrete umbrella base  
protected by strong rubber ring**

- Detachable stainless steel tube with adapters and tightening clamp
- Centralising cup within tube
- Water drainage through outlet in tube

**Unverwüster Naturbetoständer mit  
robuster Gummiumreifung**

- Hochwertiges abschraubbares Edelstahlrohr mit schirmschonenden Adaptern und Feststellschraube
- Zentriereinsatz im Rohrende
- Regenwasserabfluss durch Standrohr



**2861**

(319)



(374)

**60 kg**

Base/Fuß: Ø 656 mm

**Factory Pack: 16 pcs. per pallet / VE: 16 Stück pro Palette**

Colours Farben	Stainless Steel Tube Edelstahlrohr	Order-No. Bestell.-Nr.
<input type="radio"/> grey / grau	Ø 25-55 mm	2861-373-200
<input type="radio"/> charcoal / anthrazit	Ø 25-55 mm	2861-373-203
<input type="radio"/> grey / grau	Ø 35-70 mm	2861-374-200
<input type="radio"/> charcoal / anthrazit	Ø 35-70 mm	2861-374-203
<input type="radio"/> grey / grau	Ø 26-55 mm	2861-376-200
<input type="radio"/> charcoal / anthrazit	Ø 26-55 mm	2861-376-203
<input type="radio"/> grey / grau	Ø 61 mm	2861-377-200
<input type="radio"/> charcoal / anthrazit	Ø 61 mm	2861-377-203
<input type="radio"/> grey / grau	Ø 35-39 mm	2861-319-200
<input type="radio"/> charcoal / anthrazit	Ø 35-39 mm	2861-319-203



- Robust rubber ring protects the concrete from being damaged when rolled on its edge
- Rubber material also prevents damage to terrace tiles
- Beton wird beim Rollen des Schirmständers nicht beschädigt
- Gummiumreifung schützt die Terrassenfliesen



## 2891



**90 kg**

Base/Fuß: Ø 790 mm

**Factory Pack: 10 pcs. per pallet / VE: 10 Stück pro Palette**

Colours Farben	Stainless Steel Tube Edelstahlrohr	Order-No. Bestell.-Nr.
○ grey / grau	Ø 25-55 mm	2891-373-200
● charcoal / anthrazit	Ø 25-55 mm	2891-373-203
○ grey / grau	Ø 35-70 mm	2891-374-200
● charcoal / anthrazit	Ø 35-70 mm	2891-374-203
○ grey / grau	Ø 26-55 mm	2891-376-200
● charcoal / anthrazit	Ø 26-55 mm	2891-376-203
○ grey / grau	Ø 61 mm	2891-377-200
● charcoal / anthrazit	Ø 61 mm	2891-377-203
○ grey / grau	Ø 35-39 mm	2891-319-200
● charcoal / anthrazit	Ø 35-39 mm	2891-319-203



- 2 Stainless steel handles
- 8 gliders to prevent scratches on floor surfaces
- Castors available on request
- 2 Handgriffe aus Edelstahl
- 8 Bodenschutzstopfen
- auf Wunsch mit Rollen



<b>Factory Pack: 6 pcs. per pallet / VE: 6 Stück pro Palette</b>	
Colours Farben	Order-No. Bestell.-Nr.
<input type="radio"/> grey / grau	1255-900-200
<input checked="" type="radio"/> charcoal / anthrazit	1255-900-203
Cross diameter / Teilkreisdurchmesser 159 mm - 4 x M 10	

<b>Accessories / Zubehör</b> <b>1255</b>		Order-No. / Bestell.-Nr.
	4 castors / 4 Doppelrollen Ø 50 mm	X020-099-025-1250
	4 castors / Bockrollen Ø 100 mm	X018-299-030_SET
	4 castors / Bockrollen Ø 50 mm	X065-294-310_1250

<p><b>1265</b></p> <p><b>160 kg</b> Base/Fuß: 800 x 800 mm</p>	<b>Factory Pack: 5 pcs. per pallet / VE: 5 Stück pro Palette</b>	
	<b>Colours Farben</b>	<b>Order-No. Bestell.-Nr.</b>
	● grey / grau	1265-900-200
	● charcoal / anthrazit	1265-900-203
<p>Cross diameter / Teilkreisdurchmesser 159 mm - 4 x M 10</p>		

**Flanged Tubes  
Flanschrohre**

**NEW / NEU**

	<b>Colours Farben</b>	<b>Stainless Steel Flanged Tube Edelstahl-Flanschrohr</b>	<b>Order-No. Bestell.-Nr.</b>
	● Polished / Poliert	Ø 25-55 mm	F057-049-303_IR55
	● Polished / Poliert	Ø 62 mm	F057-049-303_IR62
	● Polished / Poliert	Ø 35-70 mm	F057-049-303_IR63
	● Stonewashed	Ø 25-55 mm	F057-049-305_IR55
	● Stonewashed	Ø 62 mm	F057-049-305_IR62
	● Stonewashed	Ø 35-70 mm	F057-049-305_IR62
<p>Aufpreis für Montageschrauben für 1255 &amp; 1265</p>			

**Adapter for side-arm-umbrellas  
Adapterplatten für Ampelschirme**

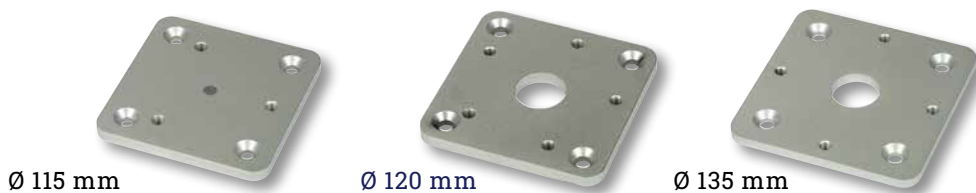

Ø 115 mm

Ø 120 mm

Ø 135 mm

	<b>Order-No. / Bestell.-Nr.</b>
Adapter for cross diameter / Adapter für Teilkreisdurchmesser Ø 115 mm - 3 x M 12	X057-115-342
Adapter for cross diameter / Adapter für Teilkreisdurchmesser Ø 120 mm - 5 x M 10	X057-120-342
Adapter for cross diameter / Adapter für Teilkreisdurchmesser Ø 135 mm - 4 x M 10	X057-135-342



**NEW / NEU**

**2060**



**230 kg**

Base/Fuß: 900 x 900 mm

**Factory Pack: 3 pcs. per pallet / VE: 3 Stück pro Palette**

Colours Farben	Order-No. Bestell.-Nr.
● grey / grau	2060-800-200
● charcoal / anthrazit	2060-800-203
Cross diameter / Teilkreisdurchmesser 150 mm - 4 x M 10	

**Jumbo Market Umbrella Base**

- Solid support for larger market umbrellas
- Stainless steel tube containing centralising cub
- Water drainage through outlet underneath base
- 4 gliders to prevent scratches on floor surfaces
- 2 galvanized steel handles

**Jumbo Marktschirmständer**

- Sicherer Halt für Großschirme
- Wetterfestes Edelstahlrohr mit Zentriereinsatz
- Regenwasserabfluß durch Standrohr
- 4 Bodenschutzstopfen
- 2 verzinkte Handgriffe



**120 kg**

Base/Fuß: 700 x 700 mm

**Factory Pack: 6 pcs. per pallet / VE: 6 Stück pro Palette**

Colours Farben	Aluminum Tube Aluminiumrohr	Order-No. Bestell.-Nr.
● grey / grau	Ø 25-55 mm	1202-408-200
● charcoal / anthrazit	Ø 25-55 mm	1202-408-203
Colours Farben	Stainless Steel Tube Edelstahlrohr	Order-No. Bestell.-Nr.
● grey / grau	Ø 35-70 mm	1207-374-200
● charcoal / anthrazit	Ø 35-70 mm	1207-374-203



	Order-No. / Bestell.-Nr.
4 castors / 4 Doppelrollen Ø 50 mm	X012-299-025_SET
4 castors / Bockrollen Ø 100 mm	X018-299-025_SET

D

# Granite Bases Granitständer

Made from select Granite or Marble  
Hergestellt aus ausgesuchtem Granit oder Marmor





# Granite Bases

- Made from select granite or marble
- Recessed grips for easy relocation
- Polished stone finish
- Detachable stainless steel tube
- Set screw with adapters and tightening clamp
- Centralising cup within tube
- Water drainage through outlet in tube
- Gliders underneath base

- Hergestellt aus ausgesuchtem Granit oder Marmor
- Griffmulden für einfaches Handling
- Polierte Oberfläche
- Abschraubbares und wetterfestes Edelstahlrohr
- Schirmschonende Adapter mit Feststellschraube
- Zentriereinsatz im Rohrende
- Regenwasserabfluss durch Standrohr
- Mit Bodenschutzstopfen

● Granite/black, Granit/schwarz (172)    ○ Marble/white, Marmor/weiß (175)    ● Granite/grey, Granit/grau (170)



round/rund

## 8430-39



Weight Gewicht ca.	Factory Pack VE Stück	Base mm Fuß mm	Stainless Steel Tube Edelstahlrohr	Order-No. Bestell.-Nr.
20 kg	44	Ø 400 mm	Ø 25-44 mm	8430-372-170
30 kg	22	Ø 500 mm	Ø 25-55 mm	8431-373-170
40 kg	20	Ø 580 mm	Ø 25-55 mm	8432-373-170
65 kg	16	Ø 650 mm	Ø 25-55 mm	8435-373-170
65 kg	16	Ø 650 mm	Ø 35-70 mm	8435-374-170
90 kg	10	Ø 700 mm	Ø 25-55 mm	8438-373-170
90 kg	10	Ø 700 mm	Ø 35-70 mm	8438-374-170
90 kg	10	Ø 700 mm	Ø 54-56 mm	8438-375-170
90 kg	10	Ø 700 mm	Ø 61 mm	8438-377-170
100 kg	10	Ø 700 mm	Ø 25-55 mm	8439-373-170
100 kg	10	Ø 700 mm	Ø 35-70 mm	8439-374-170
100 kg	10	Ø 700 mm	Ø 54-56 mm	8439-375-170
100 kg	10	Ø 700 mm	Ø 61 mm	8439-377-170
● grey/ grau				
90 kg	10	Ø 700 mm	Ø 25-55 mm	8438-373-172
90 kg	10	Ø 700 mm	Ø 35-70 mm	8438-374-172
90 kg	10	Ø 700 mm	Ø 54-56 mm	8438-375-172
90 kg	10	Ø 700 mm	Ø 61 mm	8438-377-172
● black/ schwarz				
20 kg	44	Ø 400 mm	Ø 25-44 mm	8430-372-175
30 kg	22	Ø 500 mm	Ø 25-55 mm	8431-373-175
40 kg	16	Ø 580 mm	Ø 25-55 mm	8432-373-175
○ white/ weiß				

Accessories / Zubehör  
8435, 8438, 8439



4 castors/ 4 Doppelrollen Ø 50 mm

Order-No. / Bestell.-Nr.

X012-299-020\_SET-G

square/viereckig

## 8440-48

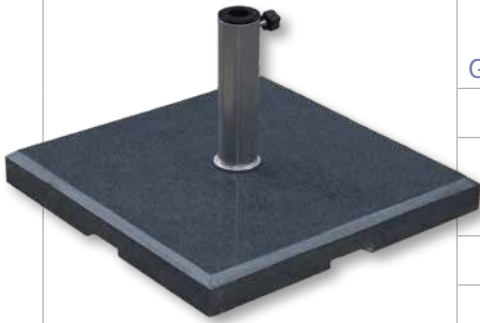

With recessed grips/  
Mit Griffmulden

Weight Gewicht ca.	Factory Pack VE Stück	Base mm Fuß mm	Stainless Steel Tube Edelstahlrohr	Order-No. Bestell.-Nr.
20 kg	44	400 x 400 mm	Ø 25-44 mm	8440-372-170
30 kg	18	500 x 500 mm	Ø 25-55 mm	8441-373-170
40 kg	16	550 x 550 mm	Ø 25-55 mm	8442-373-170
60 kg	16	600 x 600 mm	Ø 25-55 mm	8444-373-170
60 kg	16	600 x 600 mm	Ø 35-70 mm	8444-374-170
75 kg	12	640 x 640 mm	Ø 25-55 mm	8446-373-170
75 kg	12	640 x 640 mm	Ø 35-70 mm	8446-374-170
90 kg	10	700 x 700 mm	Ø 25-55 mm	8448-373-170
90 kg	10	700 x 700 mm	Ø 35-70 mm	8448-374-170
90 kg	10	700 x 700 mm	Ø 54-56 mm	8448-375-170
90 kg	10	700 x 700 mm	Ø 61 mm	8448-377-170
○ grey/ grau				
75 kg	12	640 x 640 mm	Ø 25-55 mm	8446-373-172
75 kg	12	640 x 640 mm	Ø 35-70 mm	8446-374-172
90 kg	10	700 x 700 mm	Ø 25-55 mm	8448-373-172
90 kg	10	700 x 700 mm	Ø 35-70 mm	8448-374-172
90 kg	10	700 x 700 mm	Ø 54-56 mm	8448-375-172
90 kg	10	700 x 700 mm	Ø 61 mm	8448-377-172
● black/ schwarz				



Set of 4 castors available on request for 8444, 8446 & 8448  
4-teiliger Rollensatz erhältlich für Artikel 8444, 8446 & 8448

**Accessories / Zubehör**  
8444, 8446, 8448



4 castors/ 4 Doppelrollen Ø 50 mm

Order-No. / Bestell.-Nr.

X012-299-020\_SET-G



# Granite Bases

## Balcony Umbrella Base

- Rectangular space-saving design

## Balkonschirmständer

- Rechteckiges, raumsparendes Design



rectangular/rechteckig

**8422**



**23 kg**

Base/Fuß: 500 x 285 mm

**Factory Pack: 40 pcs. per pallet / VE: 40 Stück pro Palette**

Colours Farben	Stainless Steel Tube Edelstahlrohr	Order-No. Bestell.-Nr.
● grey/ grau	Ø 25-44 mm	8422-372-170

octagonal/achteckig

**8461**

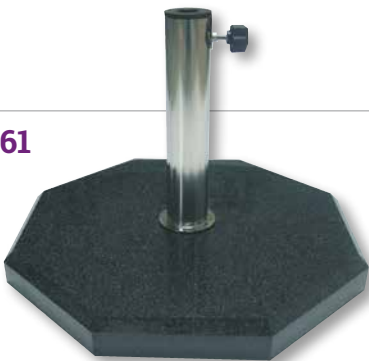

**30 kg**

Base/Fuß: Ø 500x500 mm

**Factory Pack: 20 pcs. per pallet / VE: 20 Stück pro Palette**

Colours Farben	Stainless Steel Tube Edelstahlrohr	Order-No. Bestell.-Nr.
● grey/ grau	Ø 25-55 mm	8461-373-170
● black/ schwarz	Ø 25-55 mm	8461-373-172





With rollers and handle  
Mit Rollen und Klappgriff

Gliders / Bodenschutz-Stopfen

square/viereckig



**8472**

**Factory Pack: 20 pcs. per pallet / VE: 20 Stück pro Palette**

Colours Farben	Stainless Steel Tube Edelstahlrohr	Order-No. Bestell.-Nr.
○ grey/ grau	Ø 25-55 mm	8472-373-170
● black/ schwarz	Ø 25-55 mm	8472-373-172

**40 kg**

Base/Fuß: 500 x 500 mm



With stainless steel „Comfort Handle”  
and rollers  
Mit „Komfort-Handgriff” aus Edelstahl  
und Rollen

Gliders / Bodenschutz-Stopfen

octagonal/achteckig



**8478**

**Factory Pack: 20 pcs. per pallet / VE: 20 Stück pro Palette**

Colours Farben	Stainless Steel Tube Edelstahlrohr	Order-No. Bestell.-Nr.
○ grey/ grau	Ø 25-55 mm	8478-373-170
● black/ schwarz	Ø 25-55 mm	8478-373-172

**35 kg**

Base/Fuß: Ø 500x500 mm



# Granite Bases

round/rund



**8473**  
**8474**

Weight Gewicht ca.	Factory Pack VE Stück	Base mm Fuß mm	Stainless Steel Tube Edelstahlrohr	Order-No. Bestell.-Nr.
<input type="radio"/> grey/ grau				
40 kg	16	Ø 500 mm	Ø 25-55 mm	8473-373-170
55 kg	16	Ø 580 mm	Ø 25-55 mm	8474-373-170
<input checked="" type="radio"/> black/ schwarz				
40 kg	16	Ø 500 mm	Ø 25-55 mm	8473-373-172
55 kg	16	Ø 580 mm	Ø 25-55 mm	8474-373-172

square/viereckig



**8476**  
**8477**

Weight Gewicht ca.	Factory Pack VE Stück	Base mm Fuß mm	Stainless Steel Tube Edelstahlrohr	Order-No. Bestell.-Nr.
<input type="radio"/> grey/ grau				
40 kg	20	500 x 500 mm	Ø 25-55 mm	8476-373-170
55 kg	16	550 x 550 mm	Ø 25-55 mm	8477-373-170
55 kg	16	550 x 550 mm	Ø 35-39 mm	8477-319-170
<input checked="" type="radio"/> black/ schwarz				
40 kg	20	500 x 500 mm	Ø 25-55 mm	8476-373-172
55 kg	16	550 x 550 mm	Ø 25-55 mm	8477-373-172
55 kg	16	550 x 550 mm	Ø 35-39 mm	8477-319-172

**8448**



**90 kg**

Weight Gewicht ca.	Factory Pack VE Stück	Base mm Fuß mm	Order-No. Bestell.-Nr.
90 kg	10	700 x 700 mm	8448-900-172_KD135
Cross diameter / Teilkreisdurchmesser 135 mm			

D

# Steel Bases Metallständer





## Serie A

### Steel plate with screw-on tube

- 4 gliders underneath base to prevent scratches on floor surface
- Single packed in cardboard box
- Water drainage through outlet in tube

### Metallplatte mit abschraubbarem Metallrohr

- 4 Bodenschutzstopfen zum Schutz der Terrassenfliesen
- Einzeln kartonverpackt
- Regenwasserabfluss durch Standrohr

**8201**



**17 kg**

Base/Fuß: 500 x 500 x 8 mm

**Factory Pack: 40 pcs. per pallet / VE: 40 Stück pro Palette**

Colours Farben	Metal Tube Metallrohr	Type Typ	Order-No. Bestell.-Nr.
<input type="radio"/> silver / silber	Ø 44 mm	8201	8201-380-310
<input type="radio"/> silver / silber	Ø 55 mm	8202	8201-381-310
<input checked="" type="radio"/> steel grey / eisengrau	Ø 44 mm	8250	8201-388-323
<input checked="" type="radio"/> steel grey / eisengrau	Ø 55 mm	8251	8201-389-323

**8203**



**24 kg**

Base/Fuß: 600 x 600 x 8 mm

**Factory Pack: 40 pcs. per pallet / VE: 40 Stück pro Palette**

<input type="radio"/> silver / silber	Ø 44 mm	8203	8203-380-310
<input type="radio"/> silver / silber	Ø 55 mm	8204	8203-381-310
<input type="radio"/> silver / silber	Ø 63 mm	8205	8203-382-310
<input checked="" type="radio"/> steel grey / eisengrau	Ø 44 mm	8252	8203-388-323
<input checked="" type="radio"/> steel grey / eisengrau	Ø 55 mm	8253	8203-389-323
<input checked="" type="radio"/> steel grey / eisengrau	Ø 63 mm	8254	8203-390-323

**8214**



**30 kg**

Base/Fuß: 500 x 500 x 14 mm

**Factory Pack: 32 pcs. per pallet / VE: 32 Stück pro Palette**

<input type="radio"/> silver / silber	Ø 44 mm	8228	8214-380-310
<input type="radio"/> silver / silber	Ø 55 mm	8229	8214-381-310
<input type="radio"/> silver / silber	Ø 63 mm	8233	8214-382-310
<input checked="" type="radio"/> steel grey / eisengrau	Ø 44 mm	8255	8214-388-323
<input checked="" type="radio"/> steel grey / eisengrau	Ø 55 mm	8256	8214-389-323
<input checked="" type="radio"/> steel grey / eisengrau	Ø 63 mm	8257	8214-390-323

**8212**



**40 kg**

Base/Fuß: 600 x 600 x 14 mm

**Factory Pack: 16 pcs. per pallet / VE: 16 Stück pro Palette**

<input type="radio"/> silver / silber	Ø 55 mm	8232	8212-381-310
<input type="radio"/> silver / silber	Ø 63 mm	8234	8212-382-310
<input checked="" type="radio"/> steel grey / eisengrau	Ø 55 mm	8258	8212-389-323
<input checked="" type="radio"/> steel grey / eisengrau	Ø 63 mm	8259	8212-390-323

Balcony Base  
Balkonständer



8216

23 kg

Base/Fuß: 600 x 300 x 14 mm

Factory Pack: 40 pcs. per pallet / VE: 40 Stück pro Palette

Colours Farben	Metal Tube Metallrohr	Type Typ	Order-No. Bestell.-Nr.
<input type="radio"/> silver / silber	Ø 44 mm	Balcony/Balkon	8216-380-310

With set screw and  
tightening clamp

Mit Druckplatte und  
Feststellschraube

# Serie B

- With tightening cap and adapter set
- Centralising cup within tube provides extra stability for the umbrella pole
- Adaptersystem für zentrierende und schirmschonende Klemmung
- Zentriereinsatz im Rohrende



8214

30 kg

Base/Fuß: 500 x 500 x 14 mm

Factory Pack: 32 pcs. per pallet / VE: 32 Stück pro Palette

Colours Farben	Metal Tube Metallrohr	Type Typ	Order-No. Bestell.-Nr.
<input type="radio"/> silver / silber	Ø 26-55 mm	8214	8214-391-310
<input type="radio"/> steel grey / eisengrau	Ø 26-44 mm	8261	8214-386-323
<input type="radio"/> steel grey / eisengrau	Ø 26-55 mm	8262	8214-387-323

Centralising Cups for „Series B+C“

- Our conical cups provide extra stability for the umbrella pole.  
C116-000-100 (Ø 26-44 mm)  
C117-000-100 (Ø 26-55 mm)

Zentriereinsätze für „Serie B+C“

- Unsere Einsätze zentrieren den Schirmstock im Standrohr  
C116-000-100 (Ø 26-44 mm)  
C117-000-100 (Ø 26-55 mm)

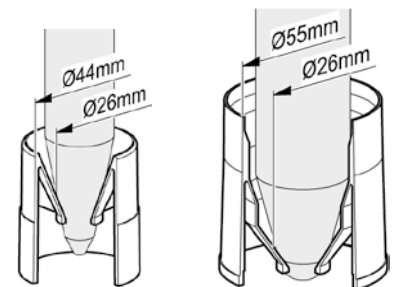

8212

40 kg

Base/Fuß: 600 x 600 x 14 mm

Factory Pack: 16 pcs. per pallet / VE: 16 Stück pro Palette

Colours Farben	Metal Tube Metallrohr	Type Typ	Order-No. Bestell.-Nr.
<input type="radio"/> silver / silber	Ø 26-55 mm	8268	8212-391-310
<input type="radio"/> steel grey / eisengrau	Ø 26-55 mm	8264	8212-387-323

## Serie C

### Steel Plates with Stainless Steel Tube

- Stainless steel tube
- Set screw with OSA adapters
- Water drainage through outlet in tube
- Centralising cup within tube
- Single packed in cardboard box
- 4 gliders underneath base to prevent scratches on floor surfaces
- Plates can be stacked
- High quality corrosion protection by cathodic electrodeposition coating

### Metallplatten mit Edelstahlrohr

- Wetterfestes Edelstahlrohr
- Schirmschonende OSA Adapter mit Feststellschraube
- Regenwasserabfluss durch Standrohr
- Zentriereinsatz im Rohrende
- Einzeln kartonverpackt
- 4 Bodenschutzstopfen zum Schutz der Terrassenfliesen
- Platten sind stapelbar
- Hoher Korrosionsschutz durch umweltfreundliche kathodische Tauchlackierung

**8231**



**30 kg**

Base/Fuß: 620 x 620 x 10 mm

**Factory Pack: 24 pcs. per pallet / VE: 24 Stück pro Palette**

Colours Farben	Stainless Steel Tube Edelstahlrohr	Order-No. Bestell.-Nr.
<input type="radio"/> white aluminum/ weiß aluminium	Ø 25-44 mm	8231-372-342
	Ø 25-55 mm	8231-373-342
	Ø 61 mm	8231-377-342
	Ø 35-70 mm	8231-374-342
<input checked="" type="radio"/> steel grey / eisengrau	Ø 25-44 mm	8231-372-339
	Ø 25-55 mm	8231-373-339
	Ø 61 mm	8231-377-339
	Ø 35-70 mm	8231-374-339

**8233**



**45 kg**

Base/Fuß: 615 x 615 x 15 mm

**Factory Pack: 16 pcs. per pallet / VE: 16 Stück pro Palette**

Colours Farben	Stainless Steel Tube Edelstahlrohr	Order-No. Bestell.-Nr.
<input type="radio"/> white aluminum/ weiß aluminium	Ø 25-44 mm	8233-372-342
	Ø 25-55 mm	8233-373-342
	Ø 61 mm	8233-377-342
	Ø 35-70 mm	8233-374-342
<input checked="" type="radio"/> steel grey / eisengrau	Ø 25-44 mm	8233-372-339
	Ø 25-55 mm	8233-373-339
	Ø 61 mm	8233-377-339
	Ø 35-70 mm	8233-374-339
	Ø 35-39 mm	8233-319-339

**8235**

**Factory Pack: 12 pcs. per pallet / VE: 12 Stück pro Palette**



**50 kg**



Base/Fuß: 730 x 730 x 12 mm

Colours Farben	Stainless Steel Tube Edelstahlrohr	Order-No. Bestell.-Nr.
○ white aluminum/ weiß aluminium	Ø 25-44 mm	8235-372-342
	Ø 25-55 mm	8235-373-342
	Ø 61 mm	8235-377-342
	Ø 35-70 mm	8235-374-342
● steel grey / eisengrau	Ø 25-44 mm	8235-372-339
	Ø 25-55 mm	8235-373-339
	Ø 61 mm	8235-377-339
	Ø 35-70 mm	8235-374-339

## Castors for Steel Bases / Rollen für Metallständer

	Colours Farben		Serie	Order-No. Bestell.-Nr.
 x 4 X020	○ silver / silber	4 Castors Ø 50 mm 4 Doppelrollen Ø 50 mm	A/B	X020-099-025_Set
	○ silver / silber	2 Rollers "Tilt-to-roll" 2 Rollen „Kipp & Roll“	A/B	X024-099-310_Set
 x 2 X024	● steel grey / eisengrau	2 Rollers "Tilt-to-roll" 2 Rollen „Kipp & Roll“	A/B	X024-099-323_Set
	○ silver / silber	4 Castors Ø 50 mm 4 Doppelrollen Ø 50 mm	C	X020-099-025_Set-16

## Hardwood Covers / Holz-Abdeckhauben

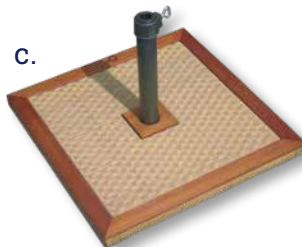
	Factory Pack VE Stück		Order-No. Bestell.-Nr.
a. 	1	a. "Hardwood Cover for 24 and 40 kg Steel Bases" „Hartholz-Abdeckhaube für 24 und 40 kg Metallständer“	8310-821-392
b. 	1	b. "Tatami Cover for 17 and 30 kg Steel Bases" „Tatami-Abdeckhaube für 17 und 30 kg Metallständer“	8310-822-392
	1	b. "Tatami Cover for 24 and 40 kg Steel Bases" „Tatami-Abdeckhaube für 24 und 40 kg Metallständer“	8310-823-392
c. 	1	c. "Hardwood-Rattan Cover for 17 and 30 kg Steel Bases" „Hartholz-Rattan Haube für 17 und 30 kg Metallständer“	8310-820-393
	1	c. "Hardwood-Rattan Cover for 17 and 30 kg Steel Bases" „Hartholz-Rattan Haube für 17 und 30 kg Metallständer“	8310-821-393

- Fits neatly over all Delschen Steel Umbrella Bases, visually uniting the umbrella with other wood products in the garden.
- Teak Oil Finish

- Dekoratives Zubehör für Delschen Metallschirmständer, passend zu weiteren Holz-Produkten im Garten oder auf der Terrasse.



# Stainless Steel Bases

## Edelstahlständer







## Stainless Steel Bases Edelstahlständer

- Roller base with stainless steel cover
- With stainless steel „Comfort Handle“
- Detachable stainless steel tube
- Stainless steel set screw with adapters and tightening clamp
- Centralising cup within tube
- Water drainage through outlet in tube
- Gliders underneath base
- Rollenständer mit Edelstahlhaube
- Mit „Komfort-Handgriff“ aus Edelstahl
- Wetterfestes Edelstahlrohr
- Schirmschonende Adapter mit Edelstahl-Feststellschraube
- Zentriereinsatz im Rohrende
- Regenwasserabfluss durch Standrohr
- Mit Bodenschutzstopfen



8476



8477



Weight Gewicht ca.	Factory Pack VE Stück	Base mm Fuß mm	Stainless Steel Tube Edelstahlrohr	Order-No. Bestell.-Nr.
40 kg	20	500 x 500 mm	Ø 25-55 mm	8476-373-303
55 kg	16	550 x 550 mm	Ø 25-55 mm	8477-373-303
55 kg	16	550 x 550 mm	Ø 35-39 mm	8477-319-303

● stainless steel/Edelstahl



[www.delschen.com](http://www.delschen.com)

Learn more about current product developments and our company online. We look forward to meeting you on our website.

Erfahren Sie Online mehr über aktuelle Produktentwicklungen und unser Unternehmen. Wir freuen uns über Ihren Besuch auf unseren Seiten und wünschen Ihnen eine sonnige Zeit!

## Ground Tubes Bodenhülsen



Factory Pack VE Stück	Material Material	Tube Rohr	Walking-through Height Durchgangshöhe	Order-No. Bestell-Nr.
10	Aluminium	Ø 25-55 mm	-160 mm	8500-052-301
10	Aluminium	Ø 25-55 mm	not affected/bleibt erhalten	8501-052-301
10	Aluminium	Ø 26-55 mm	not affected/bleibt erhalten	8501-050-301
10	Alu + Inox	Ø 54-56 mm	not affected/bleibt erhalten	8501-051-303
10	Steel/Stahl	Ø 60 mm	-160 mm	8600-060-310
10	Aluminium	Ø 60 mm	not affected/bleibt erhalten	8651-049-301

## Sealing Cap Schutzkappen

- A protective resin cap, to cover the tube hole when not in use, is included in our delivery pack.
- Eine Kunststoffkappe zum Verschließen der Bodenhülse bei Nichtgebrauch ist bereits im Lieferumfang enthalten.



		suitable for geeignet für	Order-No. Bestell-Nr.
	Hot-dip galvanised sealing cap feuerverzinkte Stahlkappe	8500, 8501	8500-001-312
	Hot-dip galvanised sealing cap feuerverzinkte Stahlkappe	8600, 8651	8600-001-312

		suitable for geeignet für	Order-No. Bestell-Nr.
	Standard resin cap/Standard-Kunststoffkappe	8500, 8501	X006-025-124
	Standard resin cap/Standard-Kunststoffkappe	8600, 8651	X006-030-100

## Lawn Anchoring Spike 7501

- The galvanised lawn spike is suitable for umbrella poles from 17 to 33 mm and comes ready to use. For soft surfaces, just step on it. For harder surfaces, hammer it into the ground.

## Rasendorn 7501

- Der verzinkte Rasendorn eignet sich für Rohrdurchmesser von 17-33 mm und ist bereits fix und fertig zusammengebaut. Er wird mit dem Fuß in den Boden getreten oder kann bei hartem Untergrund auch durch Hammerschläge auf das Winkelprofil in die Erde getrieben werden.

## Lawn Spikes 7603 + 7604

- Tube made from weather resistant aluminum
- All other steel parts are galvanised
- Water drainage through tube
- Flat, disassembled packaging
- Protects your lawn, leaving only weight marks

## Bodenspieße 7603 + 7604

- Standrohr aus wetterfestem Aluminium
- Bodenring und Einsteckspieße verzinkt
- Regenwasserabfluss durch Standrohr
- montier- bzw. demontierbare Bauteile
- besonders rasenschonend
- vielseitig verwendbar



7604-050-310



7501-033-310

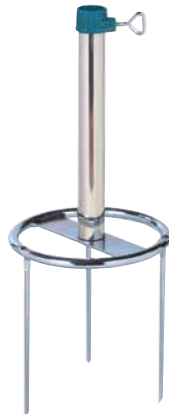

7603-025-310



7604-050-310



7604-056-310

Factory Pack VE Stück	Tube Ø mm Rohr Ø mm	Total Height Gesamthöhe	Weight Gewicht ca.	Order-No. Bestell-Nr.
20	Ø 17-33 mm	425 mm	0,9 kg	7501-033-310
12	Ø 25 mm	460 mm	1,1 kg	7603-025-310
12	Ø 26-55 mm	500 mm	2,2 kg	7604-050-310
12	Ø 25-55 mm	500 mm	2,3 kg	7604-056-310

## Patio Tile Bases Plattenständer

- Hot-dip galvanised steel frame, suitable for concrete slabs. Choice of suitable tubes on page 55.

- Feuerverzinkte Stahlrahmen, geeignet für Gehwegplatten. Passende Standrohre auf Seite 55.



**8111**

- Suitable for 4 slabs
- Geeignet für 4 Gehwegplatten



**8112**

- Suitable for 8 slabs
- Geeignet für 8 Gehwegplatten

Factory Pack VE Stück	approx. Weight Gewicht ca.	Suitable for geeignet für	Dimension mm	Order-No. Bestell-Nr.
20	9 kg	4 Slabs/Platten 400 x 400 mm	860 x 860 x 60	8111-000-312
15	13 kg	8 Slabs/Platten 400 x 400 mm	860 x 860 x 110	8112-000-312

## Safety Frame with angled Sidewalls Sicherheitsrahmen mit abgeflachten Kanten



**8121**

- Suitable for 4 slabs
- Geeignet für 4 Gehwegplatten



**8122**

- Suitable for 8 slabs
- Geeignet für 8 Gehwegplatten

Factory Pack VE Stück	approx. Weight Gewicht ca.	Suitable for geeignet für	Dimension mm	Order-No. Bestell-Nr.
20	19 kg	4 Slabs/Platten 400 x 400 mm	1090 x 1090 x 60	8121-000-312
15	25 kg	8 Slabs/Platten 400 x 400 mm	1085 x 1085 x 110	8122-000-312

## Hot Dip Galvanised Tubes Feuerverzinkte Standrohre

- Hot-dip galvanised tubes, suitable for patio tiles bases of page 54 and for in ground base socket no. F149.
- Feuerverzinkte Standrohre, geeignet für Plattenständer v. S. 54 und Bodenanker F149.



Type Typ	Tube Ø mm Rohr Ø mm	Length mm Länge mm	Order-No. Bestell.-Nr.
F 140	Ø 50 mm	300 mm	F 140-049-312
F 141	Ø 60 mm	305 mm	F 141-050-312
F 142	Ø 70 mm	400 mm	F 142-050-312

## In-Ground Socket Bodenanker

- To be set into concrete
- Zum Einbetonieren



F 149

## Assembly Device Klappadapter

- For large parasols
- Aufstellhilfe für große Sonnenschirme



F 148

## Screw-On Tube Flanschrohr mit Klappadapter

- Screw-on tube for large parasols incl. assembly device. Please contact us for more details.
- Flanschrohr mit Klappadapter für große Sonnenschirme. Sonderanfertigung nach Kundenwunsch



## Patio Tile Bases Plattenständer

### 8006

- Galvanised, suitable for 4 slabs 400 x 400 mm or 500 x 500 mm, packed in cardboard box
- Verzinkt, einstellbar für 4 Platten 400 x 400 oder 500 x 500 mm, kartonverpackt

### 8007

- Galvanised, suitable for 4 slabs 500 x 500 mm, packed in cardboard box
- Verzinkt, geeignet für 4 Platten 500 x 500 mm, kartonverpackt

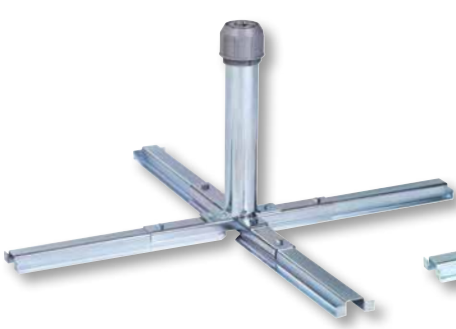

8006-050-310



8006-052-310



8007-060-312

approx. Weight Gewicht ca.	Tube Ø mm Rohr Ø mm	Factory Pack Palette Stück	Order-No. Bestell-Nr.
6 kg	Ø 26-55 mm	98	8006-050-310
6 kg	Ø 25-55 mm	98	8006-052-310
6,5 kg	Ø 60 mm	33	8007-060-312

## Add-On Weight Beschwerungsplatte

- Made from select granite
- Polished natural stone
- 2 recessed grips for easy relocation
- Suitable as add-on weight for patio tile bases
- Hergestellt aus ausgesuchtem Granit
- Poliertes Naturstein
- Zwei Griffmulden für einfaches Handling
- Geeignet als Beschwerungsplatte für Plattenständer



8450

approx. Weight Gewicht ca.	Colour Farbe	Base mm Fuß mm	Factory Pack Palette Stück	Order-No. Bestell-Nr.
19 kg	● grey/ grau	400 x 400 mm	52	8450-900-170
25 kg	● grey/ grau	480 x 480 mm	40	8456-900-170
30 kg	● grey/ grau	500 x 500 mm	32	8451-900-170

- Made from solid concrete
- 2 recessed grips for easy relocation
- Suitable as add-on weight for patio tile bases

- Hergestellt aus robustem Naturbeton
- Zwei Griffmulden für einfaches Handling
- Geeignet als Beschwerungsplatte für Plattenständer

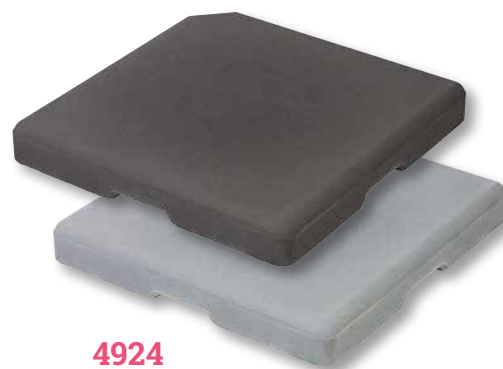

**4924**

approx. Weight Gewicht ca.	Colour Farbe	Base mm Fuß mm	Factory Pack Palette Stück	Order-No. Bestell-Nr.
27 kg	● grey/ grau	480 x 480 mm	32	4924-900-200
27 kg	● charcoal/ anthrazit	480 x 480 mm	32	4924-900-203

- Further colours on request
- Weitere Farben auf Anfrage

## Umbrella Clamps Schirmklammern

### TKS 7403

- Table Umbrella Clamp, attachable to railing or table, galvanised.
- Max. Span 32 mm

- Tischklammer für Sonnenschirme zur Befestigung an Tischen und Geländern, Stahlblech verzinkt.
- Spannweite 32 mm



**TKS 7403**

### BKS 7401

- Balcony Umbrella Clamp, attachable to railing or wall, galvanised.
- Max. Span 195 mm

- Balkonklammer für Sonnenschirme zur Befestigung an Betonbrüstungen und Geländern, Stahlblech verzinkt.
- Spannweite 195 mm



**BKS 7401**

Factory Pack VE Stück	Tube Ø mm Rohr Ø mm	Weight Gewicht ca.	Type Typ	Order-No. Bestell-Nr.
80	19-30 mm	0,24 kg	TKS 7403	7403-030-310
30	19-30 mm	0,53 kg	BKS 7401	7401-030-310



# Fold Away Base / Klappständer

## Fold Away Base Klappständer

8004

### Fold Away Base for Market Umbrellas

- Galvanised steel base with three legs, assembled and ready to use, the flat wide legs combined with the locking assembly provide stability, suitable for umbrella poles Ø 25-55 mm.

### Klappständer für Marktschirme

- Verzinkter, dreifüßiger Metallständer, zusammenklappbar, gebrauchsfertig montiert. Regenwasserabfluss durch Standrohr, breite Fußplatten, Stellschraube und Spannhaken erhöhen die Standfestigkeit, geeignet für Schirmstöcke Ø 25-55 mm.



8004

approx. Weight Gewicht ca.	Tube Ø mm Rohr Ø mm	Factory Pack VE Stück	Order-No. Bestell-Nr.
12 kg	25-55 mm	1	8004-052-310



## Spare Parts Ersatzteile



### Spare part order remarks

For attractive presentation at retail, all SB symbol marked parts are hang-hold packed and Bar-Coded. Assembly instructions are printed on back of hang-holds.

### Hinweis zu Ersatzteilbestellungen

Zur Verbesserung der Präsentation im Handel werden die mit dem SB-Symbol gekennzeichneten Ersatzteile standardmäßig SB-verpackt mit EAN-Codierung und Montageanleitung ausgeliefert.



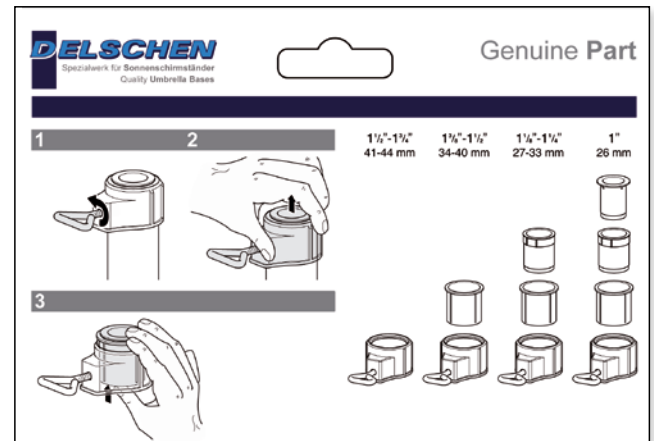
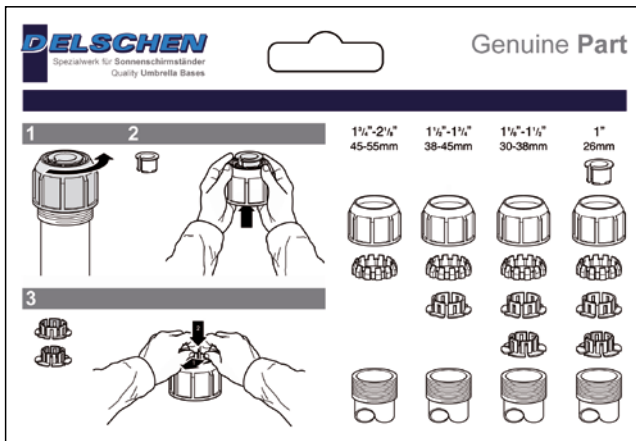

### Suitable for Article No./Passend zu Artikel: 6100

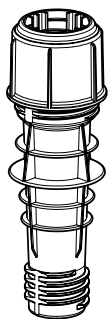

Art.-No./Art. Nr. CM 14500  
Resin tube with tightening cap,  
suitable for umbrella poles  $\varnothing$  17-33 mm  
Kunststoffrohr mit Überwurfmutter für  
Schirmstöcke  $\varnothing$  17-33 mm  
white/weiß C145-999-102  
steel grey/eisengrau C145-999-106

### Suitable for Article No./Passend zu Artikel: 6000, 6502, 6603

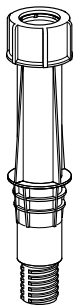

Art.-No./Art. Nr. CM 15100  
Resin tube with tightening cap,  
suitable for umbrella poles  $\varnothing$  18-38 mm  
Kunststoffrohr mit Überwurfmutter für  
Schirmstöcke  $\varnothing$  18-38 mm  
brown/braun C015-999-101  
white/weiß C015-999-102  
steel grey/eisengrau C015-999-106  
green/grün C015-999-109  
blue/blau C015-999-110\*  
sandstone/sandstone C015-999-117\*

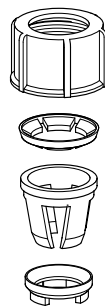

Art.-No./Art. Nr. CM 37100 (SB 37100)  
Tightening cap with adapter set  $\varnothing$  18-38 mm  
Überwurfmutter für Schirmstöcke  $\varnothing$  18-38 mm  
brown/braun C035-099-101  
white/weiß C035-099-102  
steel grey/eisengrau C035-099-106  
green/grün C035-099-109  
blue/blau C035-099-110  
sandstone/sandstone C035-099-117



### Suitable for Article No./Passend zu Artikel: 6900, 6800, 6400

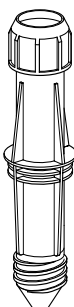

Art.-No./Art. Nr. CM 15209  
Resin tube with tightening cap, suitable  
for umbrella poles  $\varnothing$  26-55 mm  
Kunststoffrohr mit Überwurfmutter für  
Schirmstöcke  $\varnothing$  26-55 mm  
brown/braun C049-998-101\*  
white/weiß C049-998-102  
steel grey/eisengrau C049-998-106  
green/grün C049-998-109\*  
blue/blau C049-999-110\*  
sandstone/sandstone C049-998-117\*

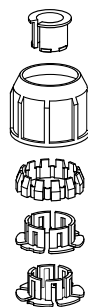





Art.-No./Art. Nr. CM 34109 (SB 34109)  
Tightening cap with adapter set  
 $\varnothing$  26-55 mm  
Überwurfmutter für Schirmstöcke  
 $\varnothing$  26-55 mm  
brown/braun C032-099-101  
white/weiß C032-099-102  
steel grey/eisengrau C032-099-106  
green/grün C032-099-109  
blue/blau C032-099-110  
sandstone/sandstone C032-099-117





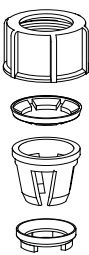

\* On request/\* nur auf Anfrage



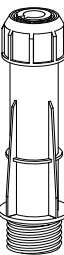

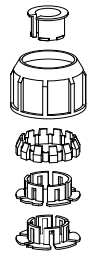
**Suitable for Article No./ Passend zu Artikel: 07001, 04101, 03701, 04001, 04251, 05001, 46038**

 	<p>Art.-No./Art. Nr. CM 35109 (SB 35109) Resin tube with tightening cap, suitable for umbrella poles Ø 18-38 mm Kunststoffrohr mit Überwurfmutter für Schirmstöcke Ø 18-38 mm</p> <table border="0"> <tr><td>brown/braun</td><td>C019-999-101</td></tr> <tr><td>white/weiß</td><td>C019-999-102</td></tr> <tr><td>steel grey/eisengrau</td><td>C019-999-106</td></tr> <tr><td>green/grün</td><td>C019-999-109</td></tr> <tr><td>blue/blau</td><td>C019-999-110</td></tr> <tr><td>sandstone/sandstone</td><td>C019-999-117</td></tr> </table>	brown/braun	C019-999-101	white/weiß	C019-999-102	steel grey/eisengrau	C019-999-106	green/grün	C019-999-109	blue/blau	C019-999-110	sandstone/sandstone	C019-999-117	 	<p>Art.-No./Art.Nr. CM 37100 (SB 37100) Tightening cap with adapter set Ø 18-38 mm Überwurfmutter für Schirmstöcke Ø 18-38 mm</p> <table border="0"> <tr><td>brown/braun</td><td>C035-099-101</td></tr> <tr><td>white/weiß</td><td>C035-099-102</td></tr> <tr><td>steel grey/eisengrau</td><td>C035-099-106</td></tr> <tr><td>green/grün</td><td>C035-099-109</td></tr> <tr><td>blue/blau</td><td>C035-099-110</td></tr> <tr><td>sandstone/sandstone</td><td>C035-099-117</td></tr> </table>	brown/braun	C035-099-101	white/weiß	C035-099-102	steel grey/eisengrau	C035-099-106	green/grün	C035-099-109	blue/blau	C035-099-110	sandstone/sandstone	C035-099-117
brown/braun	C019-999-101																										
white/weiß	C019-999-102																										
steel grey/eisengrau	C019-999-106																										
green/grün	C019-999-109																										
blue/blau	C019-999-110																										
sandstone/sandstone	C019-999-117																										
brown/braun	C035-099-101																										
white/weiß	C035-099-102																										
steel grey/eisengrau	C035-099-106																										
green/grün	C035-099-109																										
blue/blau	C035-099-110																										
sandstone/sandstone	C035-099-117																										

**Suitable for Article No./Passend zu Artikel: 05002, 46055**

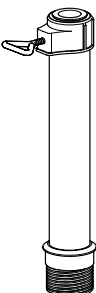
 	<p>Art.-No./Art. Nr. CM 18109 (SB 18109) Resin tube with tightening cap, suitable for umbrella poles Ø 26-55 mm Kunststoffrohr mit Überwurfmutter für Schirmstöcke Ø 26-55 mm</p> <table border="0"> <tr><td>brown/braun</td><td>C018-999-101</td></tr> <tr><td>white/weiß</td><td>C018-999-102</td></tr> <tr><td>steel grey/eisengrau</td><td>C018-999-106</td></tr> <tr><td>green/grün</td><td>C018-999-109</td></tr> <tr><td>blue/blau</td><td>C018-999-110</td></tr> <tr><td>sandstone/sandstone</td><td>C018-999-117</td></tr> </table>	brown/braun	C018-999-101	white/weiß	C018-999-102	steel grey/eisengrau	C018-999-106	green/grün	C018-999-109	blue/blau	C018-999-110	sandstone/sandstone	C018-999-117	 	<p>Art.-No./Art. Nr. CM 34109 (SB 34109) Tightening cap with adapter set Ø 26-55 mm Überwurfmutter für Schirmstöcke Ø 26-55 mm</p> <table border="0"> <tr><td>brown/braun</td><td>C032-099-101</td></tr> <tr><td>white/weiß</td><td>C032-099-102</td></tr> <tr><td>steel grey/eisengrau</td><td>C032-099-106</td></tr> <tr><td>green/grün</td><td>C032-099-109</td></tr> <tr><td>blue/blau</td><td>C032-099-110</td></tr> <tr><td>sandstone/sandstone</td><td>C032-099-117</td></tr> </table>	brown/braun	C032-099-101	white/weiß	C032-099-102	steel grey/eisengrau	C032-099-106	green/grün	C032-099-109	blue/blau	C032-099-110	sandstone/sandstone	C032-099-117
brown/braun	C018-999-101																										
white/weiß	C018-999-102																										
steel grey/eisengrau	C018-999-106																										
green/grün	C018-999-109																										
blue/blau	C018-999-110																										
sandstone/sandstone	C018-999-117																										
brown/braun	C032-099-101																										
white/weiß	C032-099-102																										
steel grey/eisengrau	C032-099-106																										
green/grün	C032-099-109																										
blue/blau	C032-099-110																										
sandstone/sandstone	C032-099-117																										

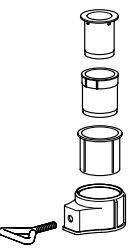
**Suitable for Article No./Passend zu Artikel: M7001, M4101, M3701, M4001, M4251, M5001, 46042**

 	<p>Art.-No./Art. Nr. RC 44800 (SB 44800) Aluminium tube with set screw and 3 adapters, for umbrella poles Ø 26-44 mm Aluminiumrohr mit Abschlußring und 3-fach Adapter für Schirmstöcke Ø 26-44 mm</p> <table border="0"> <tr><td>brown/braun</td><td>A480-999-321</td></tr> <tr><td>white/weiß</td><td>A480-999-320</td></tr> <tr><td>steel grey/eisengrau</td><td>A480-999-323</td></tr> <tr><td>green/grün</td><td>A480-999-327</td></tr> <tr><td>blue/blau</td><td>A480-999-326</td></tr> <tr><td>sandstone/sandstone</td><td>A480-999-329</td></tr> </table>	brown/braun	A480-999-321	white/weiß	A480-999-320	steel grey/eisengrau	A480-999-323	green/grün	A480-999-327	blue/blau	A480-999-326	sandstone/sandstone	A480-999-329	 	<p>Art.-No./Art. Nr. CM 87099 (SB 87099) Tightening ring with set screw and 3 adapters, suitable for umbrella poles Ø 26-44 mm Abschlußring mit 3-fach Adapter für Schirmstöcke Ø 26-44 mm</p> <table border="0"> <tr><td>brown/braun</td><td>C087-099-101</td></tr> <tr><td>white/weiß</td><td>C087-099-102</td></tr> <tr><td>steel grey/eisengrau</td><td>C087-099-106</td></tr> <tr><td>green/grün</td><td>C087-099-109</td></tr> <tr><td>blue/blau</td><td>C087-099-110</td></tr> <tr><td>sandstone/sandstone</td><td>C087-099-117</td></tr> </table>	brown/braun	C087-099-101	white/weiß	C087-099-102	steel grey/eisengrau	C087-099-106	green/grün	C087-099-109	blue/blau	C087-099-110	sandstone/sandstone	C087-099-117
brown/braun	A480-999-321																										
white/weiß	A480-999-320																										
steel grey/eisengrau	A480-999-323																										
green/grün	A480-999-327																										
blue/blau	A480-999-326																										
sandstone/sandstone	A480-999-329																										
brown/braun	C087-099-101																										
white/weiß	C087-099-102																										
steel grey/eisengrau	C087-099-106																										
green/grün	C087-099-109																										
blue/blau	C087-099-110																										
sandstone/sandstone	C087-099-117																										

**Suitable for Article No./Passend zu Artikel: 46057, 50053, 61055, 60053, 70055**

 	<p>Art.-No./Art. Nr. RC 60359 (SB 60359) Aluminium tube with tightening cap, suitable for umbrella poles Ø 26-55 mm Aluminiumrohr mit Überwurfmutter für Schirmstöcke Ø 26-55 mm</p> <table border="0"> <tr><td>brown/braun</td><td>A601-999-321</td></tr> <tr><td>white/weiß</td><td>A601-999-320</td></tr> <tr><td>steel grey/eisengrau</td><td>A601-999-323</td></tr> <tr><td>green/grün</td><td>A601-999-327</td></tr> <tr><td>blue/blau</td><td>A601-999-326</td></tr> <tr><td>sandstone/sandstone</td><td>A601-999-329</td></tr> </table>	brown/braun	A601-999-321	white/weiß	A601-999-320	steel grey/eisengrau	A601-999-323	green/grün	A601-999-327	blue/blau	A601-999-326	sandstone/sandstone	A601-999-329	 	<p>Art.-No./Art. Nr. CM 34109 (SB 34109) Tightening cap with adapter set Ø 26-55 mm Überwurfmutter für Schirmstöcke Ø 26-55 mm</p> <table border="0"> <tr><td>brown/braun</td><td>C032-099-101</td></tr> <tr><td>white/weiß</td><td>C032-099-102</td></tr> <tr><td>steel grey/eisengrau</td><td>C032-099-106</td></tr> <tr><td>green/grün</td><td>C032-099-109</td></tr> <tr><td>blue/blau</td><td>C032-099-110</td></tr> <tr><td>sandstone/sandstone</td><td>C032-099-117</td></tr> </table>	brown/braun	C032-099-101	white/weiß	C032-099-102	steel grey/eisengrau	C032-099-106	green/grün	C032-099-109	blue/blau	C032-099-110	sandstone/sandstone	C032-099-117
brown/braun	A601-999-321																										
white/weiß	A601-999-320																										
steel grey/eisengrau	A601-999-323																										
green/grün	A601-999-327																										
blue/blau	A601-999-326																										
sandstone/sandstone	A601-999-329																										
brown/braun	C032-099-101																										
white/weiß	C032-099-102																										
steel grey/eisengrau	C032-099-106																										
green/grün	C032-099-109																										
blue/blau	C032-099-110																										
sandstone/sandstone	C032-099-117																										

## Suitable for Article No./Passend zu Artikel: 46057, 50053, 61055, 60053, 70055

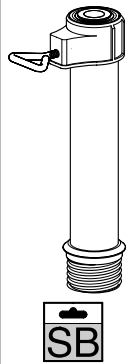

Art.-No./Art. Nr. RC 60226 (SB 60226)  
Aluminium tube with set screw and  
5 adapters, for umbrella poles  $\varnothing$  26-56 mm  
Aluminiumrohr mit Abschlußring und 5-fach  
Adapter für Schirmstöcke  $\varnothing$  26-56 mm  
brown/braun A601-899-321  
white/weiß A601-899-320  
steel grey/eisengrau A601-899-323  
green/grün A601-899-327  
blue/blau A601-899-326\*  
sandstone/sandstone A601-899-329\*

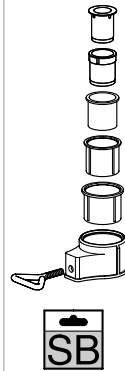

Art.-No./Art. Nr. CM 97099 (SB 97099)  
Tightening ring with set screw and  
5 adapters, suitable for umbrella poles  $\varnothing$   
26-56 mm  
Abschlußring mit 5-fach Adapter für  
Schirmstöcke  $\varnothing$  26-56 mm  
brown/braun C097-099-101  
white/weiß C097-099-102  
steel grey/eisengrau C097-099-106  
green/grün C097-099-109  
blue/blau C097-099-110\*  
sandstone/sandstone C097-099-117\*

## Suitable for Article No./Passend zu Artikel: K4101

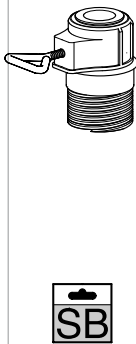

Art.-No./Art. Nr. RC 44100 (SB 44100)  
Short aluminium tube with set screw and  
3 adapters, for umbrella poles  $\varnothing$  26-44 mm  
Aluminiumrohr mit Abschlußring und  
3-fach Adapter für Schirmstöcke  $\varnothing$  26-44  
mm  
brown/braun A480-999-321\_0100  
white/weiß A480-999-320\_0100  
steel grey/eisengrau A480-999-323\_0100  
green/grün A480-999-327\_0100  
blue/blau A480-999-326\_0100  
sandstone/sandstone A480-999-329\_0100



Art.-No./Art. Nr. CM 87099 (SB 87099)  
Tightening ring with set screw and  
3 adapters, suitable for umbrella  
poles  $\varnothing$  26-44 mm  
Abschlußring mit 3-fach Adapter für  
Schirmstöcke  $\varnothing$  26-44 mm  
brown/braun C087-099-101  
white/weiß C087-099-102  
steel grey/eisengrau C087-099-106  
green/grün C087-099-109  
blue/blau C087-099-110  
sandstone/sandstone C087-099-117

## Suitable for concrete &amp; granite bases/geeignet für Beton- &amp; Granitständer

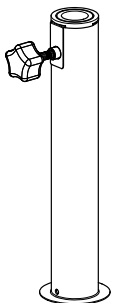

Art.-No./Art. Nr. IR43-049-303  
Stainless steel tube with set screw and 2,  
adapters for umbrella poles  $\varnothing$  25-44 mm  
(incl. additional adapter OSA 39)  
Edelstahlrohr mit Druckplatte, Schraube  
und 2 Adaptern für Schirmstöcke  
 $\varnothing$  25-44 mm  
(incl. Alternativ-Adapter OSA 39)



Art.-No./Art. Nr. C141-199-108  
Set of 2 adapters, suitable for umbrella  
poles  $\varnothing$  25-44 mm  
(incl. additional adapter OSA 39)  
2-fach Adapterset, geeignet für Schirm-  
stöcke  $\varnothing$  25-44 mm  
(incl. Alternativ-Adapter OSA 39)



Art.-No./Art. Nr. C180-000-108  
Adapter  $\varnothing$  41 mm  
**NEW • NEU**

## Suitable for concrete &amp; granite bases/geeignet für Beton- &amp; Granitständer



Art.-No./Art. Nr. IR55-049-303  
Stainless steel tube with set screw and 3,  
adapters for umbrella poles  $\varnothing$  25-55 mm  
(incl. additional adapter OSA 39 & 51)  
Edelstahlrohr mit Druckplatte, Schraube  
und 3 Adaptern für Schirmstöcke  
 $\varnothing$  25-55 mm  
(incl. Alternativ-Adapter OSA 39 & 51)



Art.-No./Art. Nr. C138-199-108  
Set of 3 adapters, suitable for umbrella  
poles  $\varnothing$  25-55 mm (incl. additional adapt-  
er OSA 39 & 51)  
3-fach Adapterset, geeignet für Schirm-  
stöcke  $\varnothing$  25-55 mm  
(incl. Alternativ-Adapter OSA 39 & 51)

## Suitable for concrete & granite bases/geeignet für Beton- & Granitständer

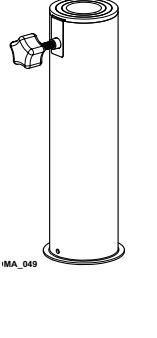
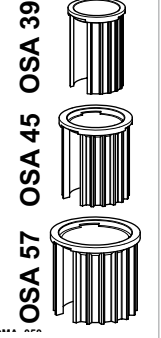
	<p>Art.-No./Art. Nr. IR63-049-303</p> <p>Stainless steel tube with set screw and 3, adapters for umbrella poles Ø 35-70 mm (incl. additional adapter OSA 51 &amp; 64)</p> <p>Edelstahlrohr mit Druckplatte, Schraube und 3 Adaptern für Schirmstöcke Ø 35-70 mm (incl. Alternativ-Adapter OSA 51 &amp; 64)</p>	 <p>OSA 39 OSA 45 OSA 57</p>	<p>Art.-No./Art. Nr. C137-199-108</p> <p>Set of 3 adapters, suitable for umbrella poles Ø 35-70 mm (incl. additional adapter OSA 51 &amp; 64)</p> <p>3-fach Adapterset, geeignet für Schirmstöcke Ø 35-70 mm (incl. Alternativ-Adapter OSA 51 &amp; 64)</p>
---	--	---	---

## Suitable for concrete & granite bases/geeignet für Beton- & Granitständer

	<p>Art.-No./Art. Nr. IR62-049-303</p> <p>Stainless steel tube with 2 set screws for umbrella poles up to Ø 61 mm</p> <p>Edelstahlrohr mit Druckplatte und 2 Feststellschrauben für Schirmstöcke bis Ø 61 mm</p>		<p>Art.-No./Art. Nr. X025-0M8-310</p> <p>Stainless steel set screw Edelstahl-Feststellschraube</p> <p>Inox tightening clamp/ Edelstahl-Druckplatte</p> <table border="0"> <tr> <td>for tube/für Rohr IR43</td> <td>X013-043-303</td> </tr> <tr> <td>for tube/für Rohr IR55</td> <td>X013-055-303</td> </tr> <tr> <td>for tube/für Rohr IR62</td> <td>X013-062-303</td> </tr> <tr> <td>for tube/für Rohr IR63</td> <td>X013-070-303</td> </tr> </table>	for tube/für Rohr IR43	X013-043-303	for tube/für Rohr IR55	X013-055-303	for tube/für Rohr IR62	X013-062-303	for tube/für Rohr IR63	X013-070-303
for tube/für Rohr IR43	X013-043-303										
for tube/für Rohr IR55	X013-055-303										
for tube/für Rohr IR62	X013-062-303										
for tube/für Rohr IR63	X013-070-303										

## Suitable for steel bases/geeignet für Metallständer

	<p>Serie/Series A</p> <p>Steel tube with inox set screw for umbrella poles up to Ø 44 mm</p> <p>Metallrohr mit Edelstahl-Feststellschraube für Schirmstöcke bis Ø 44 mm</p> <table border="0"> <tr> <td>silver/silber</td> <td>MP44-049-310</td> </tr> <tr> <td>steel grey/eisengrau</td> <td>MP44-049-323</td> </tr> </table>	silver/silber	MP44-049-310	steel grey/eisengrau	MP44-049-323		<p>Serie/Series A</p> <p>Steel tube with inox set screw for umbrella poles up to Ø 55 mm</p> <p>Metallrohr mit Edelstahl-Feststellschraube für Schirmstöcke bis Ø 55 mm</p> <table border="0"> <tr> <td>silver/silber</td> <td>MP56-049-310</td> </tr> <tr> <td>steel grey/eisengrau</td> <td>MP56-049-323</td> </tr> </table>	silver/silber	MP56-049-310	steel grey/eisengrau	MP56-049-323
silver/silber	MP44-049-310										
steel grey/eisengrau	MP44-049-323										
silver/silber	MP56-049-310										
steel grey/eisengrau	MP56-049-323										

## Suitable for steel bases/geeignet für Metallständer

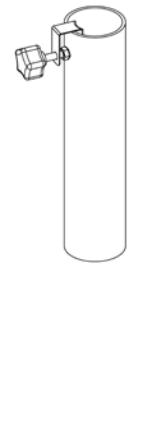
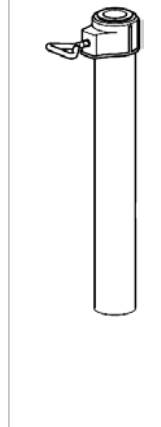
	<p>Serie/Series A</p> <p>Steel tube with inox set screw for umbrella poles up to Ø 63 mm</p> <p>Metallrohr mit Edelstahl-Feststellschraube für Schirmstöcke bis Ø 63 mm</p> <table border="0"> <tr> <td>silver/silber</td> <td>MP63-049-310</td> </tr> <tr> <td>steel grey/eisengrau</td> <td>MP63-049-323</td> </tr> </table>	silver/silber	MP63-049-310	steel grey/eisengrau	MP63-049-323		<p>Serie/Series B</p> <p>Steel tube with adapter set for umbrella poles Ø 26-44 mm</p> <p>Metallrohr mit Adaptersystem für Schirmstöcke Ø 26-44 mm</p> <table border="0"> <tr> <td>steel grey/eisengrau</td> <td>MP44-899-323</td> </tr> </table>	steel grey/eisengrau	MP44-899-323
silver/silber	MP63-049-310								
steel grey/eisengrau	MP63-049-323								
steel grey/eisengrau	MP44-899-323								

## Suitable for steel bases/geeignet für Metallständer

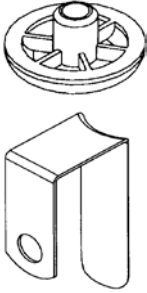
	<p>Serie/Series B</p> <p>Steel tube with adapter set for umbrella poles <math>\varnothing</math> 26-55 mm</p> <p>Metallrohr mit Adaptersystem für Schirmstöcke <math>\varnothing</math> 26-55 mm</p> <p>silver/silber MP55-999-310 steel grey/eisengrau MP55-999-323</p>		<p>Glider, suitable for 8 mm steel plates Bodenschutz-Stopfen für 8 mm Platten Art.No./Art. Nr. X001-070-108</p> <p>Glider, suitable for 14 mm steel plates Bodenschutz-Stopfen für 14 mm Platten Art.No./Art. Nr. X001-071-108</p> <p>Tightening clamp, suitable for Series A Druckplatte, passend zu Serie A Art.No./Art. Nr. X013-001-310</p>
---	--	---	--

## Centralising cups/Zentriereinsätze

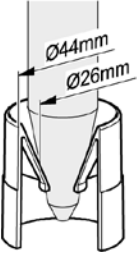
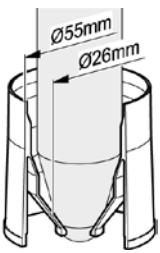
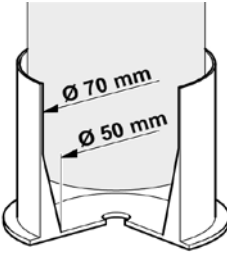
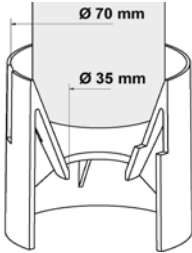

<p>Our conical cups provide extra stability for the umbrella pole. Unsere Einsätze zentrieren den Schirmstock im Standrohr.</p>			
			
<b>C116-000-100</b>	<b>C117-000-100</b>	<b>C082-000-100</b>	<b>C135-000-108</b>

## Suitable for Concrete and Granite Bases/Geeignet für Beton- und Granitständer

	<p>Bag with 4 gliders: Art.-No. X001-004-108</p>	<p>Beutel mit 4 Stopfen: Art.-Nr. X001-004-108</p>
---	--	--

## NEW • NEU

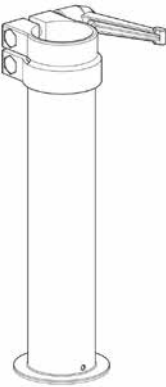
## Suitable for Concrete, Granite &amp; Steel Bases/Passend zu Beton-, Granit- und Metallständer

	<p>IR45-099-303</p> <p>Stainless steel tube with quick release for umbrella poles <math>\varnothing</math> 35-39 mm Edelstahlrohr mit Schnellspanner für Schirmstöcke <math>\varnothing</math> 35-39 mm</p> <p>IR55-051-303</p> <p>Stainless steel tube with quick release for umbrella poles <math>\varnothing</math> 54-56 mm Edelstahlrohr mit Schnellspanner für Schirmstöcke <math>\varnothing</math> 54-56 mm</p>		<p>X066-099-108</p> <p>Quick release for umbrella poles <math>\varnothing</math> 35-39 mm Schnellspanner für Schirmstöcke <math>\varnothing</math> 35-39 mm</p> <p>X014-099-108</p> <p>Quick release for umbrella poles <math>\varnothing</math> 54-56 mm Schnellspanner für Schirmstöcke <math>\varnothing</math> 54-56 mm</p>
---	---	---	---



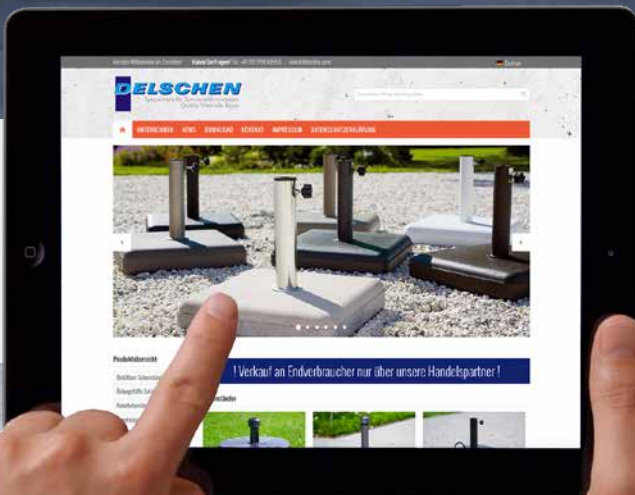

Learn more about current product developments and our company online. We look forward to meeting you on our website.

Erfahren Sie Online mehr über aktuelle Produktentwicklungen und unser Unternehmen. Wir freuen uns über Ihren Besuch auf unseren Seiten und wünschen Ihnen eine sonnige Zeit!

[www.delschen.com](http://www.delschen.com)

J. Delschen GmbH & Co. KG  
 Mülhausener Str. 56 · D-47929 Grefrath

Postfach 101054 · D-47919 Grefrath

Telefon +49 (0)2158-4095-0  
 Fax +49 (0)2158-4095-10

info@delschen.com  
 www.delschen.com



[WWW.DELSCHEN.COM](http://WWW.DELSCHEN.COM)

Learn more about current product developments and our company online. We look forward to meeting you on our website.

Erfahren Sie Online mehr über aktuelle Produktentwicklungen und unser Unternehmen. Wir freuen uns über Ihren Besuch auf unseren Seiten und wünschen Ihnen eine sonnige Zeit!

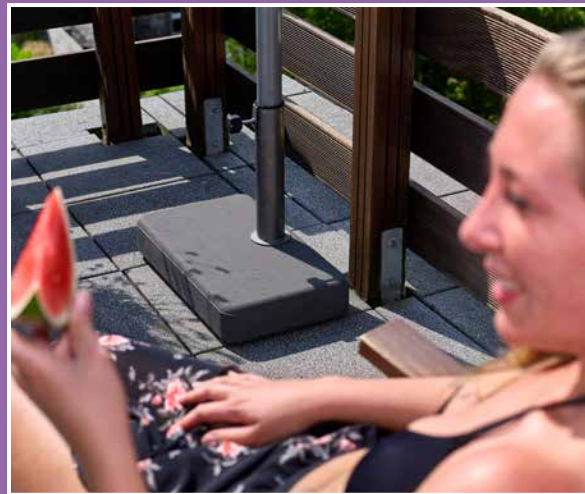

Design & Print by Keuck Medien GmbH & Co.KG  
 www.keuck-medien.de

We reserve the right to alter specifications or materials without prior notice.  
 Produktänderungen, Farbabweichungen, Irrtum und Druckfehler vorbehalten.

